



ZROADZ

DYNAMIC LED MOUNTING SOLUTIONS



PROFESSIONAL INSTALL RECOMMENDED

2018 JEEP WRANGLER JL

PART#: Z374631-KIT / Z374631-KIT2 / Z374831-KIT4

FRONT ROOF / A-PILLAR LED LIGHT MOUNTS

PARTS ARE PATENT PENDING. ALL RIGHTS RESERVED - COPYRIGHT ©2018 - ZROADZ LED, INC.

PARTS INCLUDED

- (1) Driver Side Mounting Bracket
- (1) Passenger Side. Mounting Bracket

LED LIGHTS INCLUDED

- Z374631-KIT - (1) 50" Single Row LED Light Bar
- Z374631-KIT2 - (1) 50" Single Row LED Light Bar & (2) 3" Pods
- Z374631-KIT4 - (1) 50" Single Row LED Light Bar & (4) 3" Pods

HARDWARE INCLUDED

- (1) - DriverSide Gasket Base Support
- (1) - Passanger Side Gasket Base Support
- (8) - Gasket Strips
- (4) - ZROADZ Logo Backing Plate
- (4) - 3/4" x 1/4" Aluminum Spacers
- (4) - 3/8" x .810 Aluminum Spacers
- (4) - 3/4" x 13/32" Aluminum Spacers
- (4) - M6 x 1mm x 50mm Round Head Black Screws
- (4) - M8 x 1.25mm x 30mm Button Head Black Screws
- (8) - 10-32 x 1/2" Button Head Screws
- (8) - #10-32 Flange Nuts
- (2) - Torx Screws
- (2) - 5/16" Black Flat Washers
- (1) - 1" Long Torx T-40 Bit
- (1) - Power Cable Wiring Harness

TOOLS REQUIRED

- Air Hose & Nozzle
- Alcohol Cleaning Solution
- Cleaning Rag
- Socket Set & Ratchet Tool
- Ratchet Extensions
- Various Wrenches
- Dikes or Snips
- Torq Bit Set
- Heat Gun

INSTALLATION GUIDE

START HERE

PLEASE READ AND UNDERSTAND ALL INSTRUCTIONS BEFORE INSTALLATION. Auto makers offer varied models to each vehicle and occasionally manufacture more than one body style of the same model. To assure your part is correct; our tech department can be contacted at orders@zroadz.com to verify fitment and assist with technical questions. All other inquires can be directed to orders@zroadz.com. In the event you do not have internet access please call 844-653-8040

* APPLICATION MODELS VARY. WE RECOMMEND TO VERIFY FITMENT BEFORE BEGINNING INSTALLATION PROCESS.
* IMAGES FEATURED IN THE INSTRUCTION DOCUMENTS MAY NOT ALWAYS EXACTLY MATCH YOUR MODEL OR PART.

BEFORE YOU BEGIN

START HERE: Turn off engine, chalk tires with stop block, open the hood and disconnect the battery.

LED LIGHT BRACKET INSTALLATION

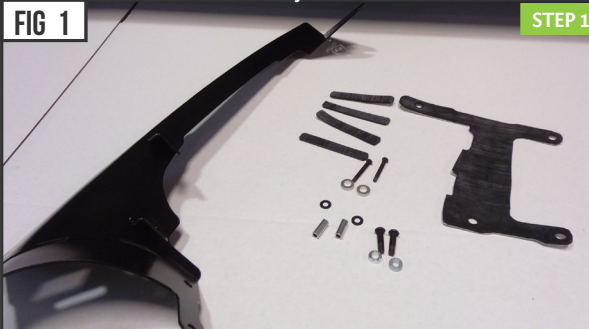

STEP 1

1) Layout and organize all the provided parts.

PRO TIP:

APPLY A PROTECTIVE LAYER OF 3M MASKING TAPE AROUND THE APPLICATION AREA.

STEP 2

SEE FIGURE 2

2) Match up the gaskets to the appropriate mounting bracket.

Peel off the gasket protective tape.

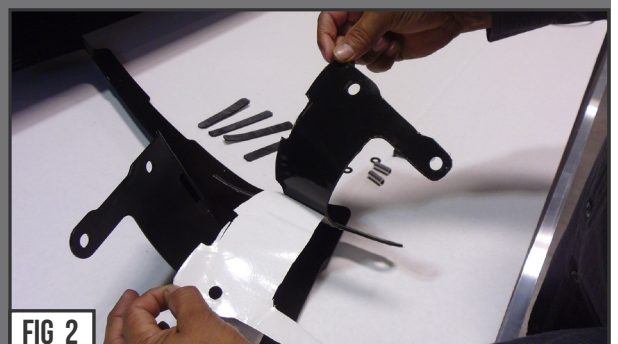

FIG 2



ZROADZ

DYNAMIC LED MOUNTING SOLUTIONS

LED LIGHT BRACKET INSTALLATION - CONTINUED

PARTS ARE PATENT PENDING. ALL RIGHTS RESERVED - COPYRIGHT ©2018 - ZROADZ LED, INC.

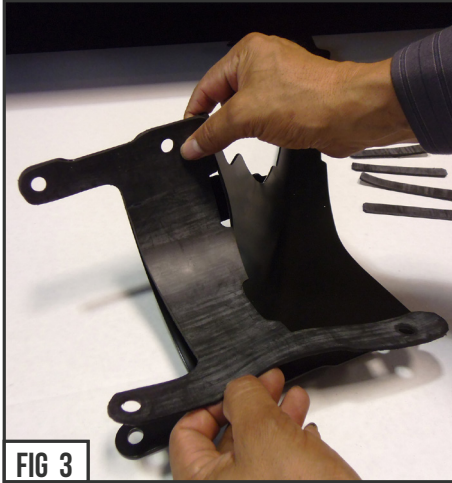

STEPS 3 & 4

SEE FIGURE 3 & 4

Identify which Gasket goes on Driver Side and which Gasket goes on Passenger side. Each has a pattern that matches the Mounting Brackets.

3) Carefully put gasket into position sticky side down facing Mounting Brackets.

4) Take the Gasket strips and put them into place along the A-Pillar section as seen in Figure #4.

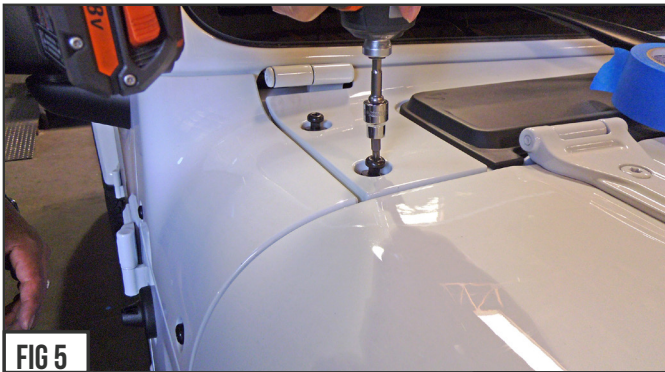
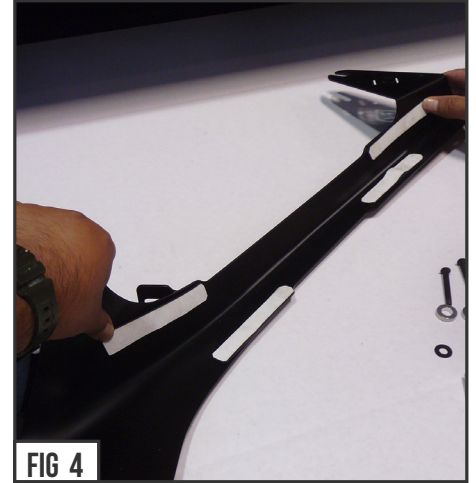

STEP 5

SEE FIGURES 5 & 6

5) Remove JEEP A-Pillar Screws from vehicle. There are (2) on top near Hood Hinge and (2) on side near door hinge as seen in Figures #5 & #6.

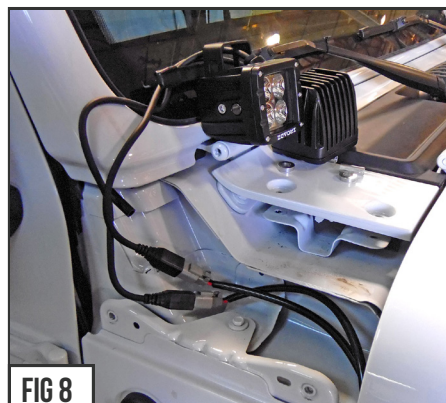

STEP 6

INSTALLERS NOTE: Mock Up LED Lights and plumb wires.

SEE FIGURES 7 - 9

6) With the Screws removed, you should now be able to remove the Vehicle's A-Pillar / Fender panel. Plumb any and all LED Lights power harness through and behind fender / hood. It is recommended and designed to hide the roof level LED Light Bar Power Wire behind the ZROADZ Mounting Brackets. Now is the time to carefully set LED Light Bar up on roof area and mock up the power wire along Vehicle's A-Pillar exterior.

LED LIGHT BRACKET INSTALLATION - CONTINUED



ZROADZ

DYNAMIC LED MOUNTING SOLUTIONS

LED LIGHT BRACKET INSTALLATION - CONTINUED

PARTS ARE PATENT PENDING. ALL RIGHTS RESERVED - COPYRIGHT ©2018 - ZROADZ LED, INC.

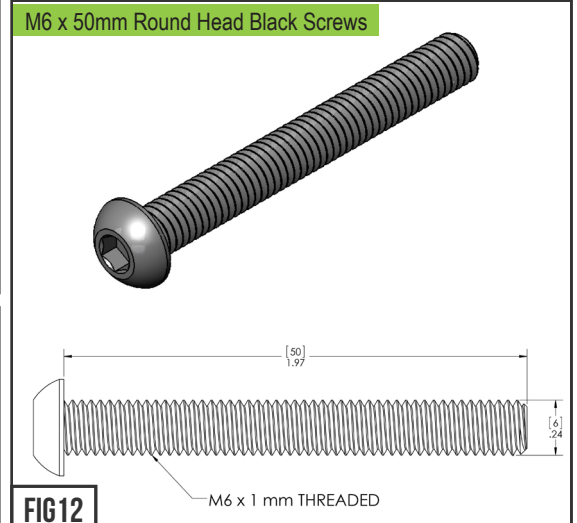
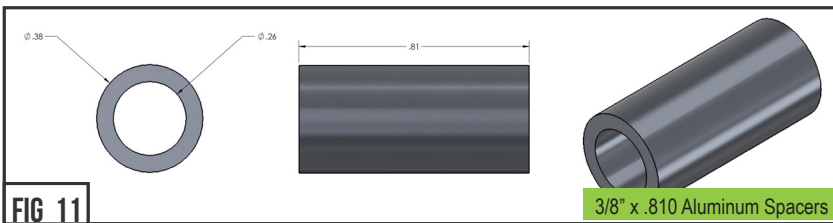
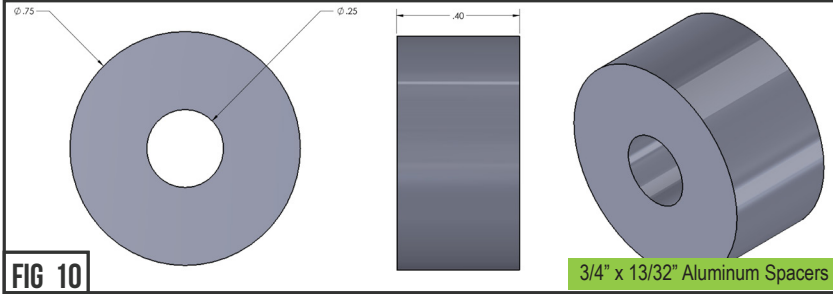

STEP 7 INSTALLERS NOTE: Put into place ZROADZ Mounting Brackets.

SEE FIGURES 10 - 12

7) Put back into place and install Vehicle's Fender Panel with new supplied hardware as follows:
Assemble the provided Aluminum Spacers (3/4" x 13/32" - Figure #10) & (3/8" x .810" - Figure #11) as seen & configured in Figure #15 and put them into the Vehicle's TOP mounting locations. The Aluminum Spacers will be stacked on top of each other with the long one going in first.

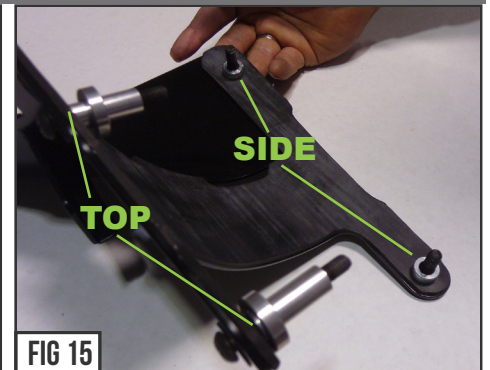

STEP 8

SEE FIGURE 16

8) Take the other provided Aluminum Spacers (3/4" x 1/4" Aluminum Spacers) and insert them into the Vehicle's SIDE mounting locations.



STEP 9

SEE FIGURE 17

9) Carefully put into place the ZROADZ Mounting Brackets to Jeep JL A-Pillar. Check for clearances and proper placement of gaskets for coverage and protection of vehicle finish. Route & hide the Roof Level LED Light Bar Power Harness down the Vehicle's A-Pillar behind ZROADZ Mounting Bracket. Use the provided M6 x 50mm Round Head Black Screws to secure mounts to Jeep.

LED LIGHT BRACKET INSTALLATION - CONTINUED



ZROADZ

DYNAMIC LED MOUNTING SOLUTIONS

LED LIGHT BRACKET INSTALLATION - CONTINUED

PARTS ARE PATENT PENDING. ALL RIGHTS RESERVED - COPYRIGHT ©2018- ZROADZ LED, INC.

INSTALLERS NOTE: STEP #10 DOES NOT APPLY TO PARTS: Z374831 / Z374831-KIT

STEP 10

SEE FIGURES 18 & 19

10) Install any ZROADZ LED Light Pods to the pre-determined A-Pillar Tabs using the provided LED Light Pod Hardware.

- M8 x 20mm Bolts
- M8 Lock Washers
- M8 Hex Nuts



FIG 18

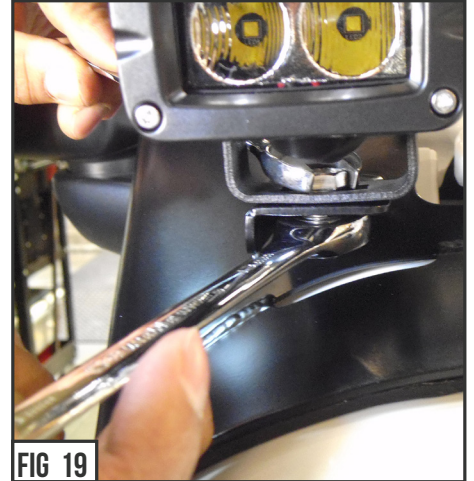

FIG 19

ROOF LEVEL LED LIGHT BAR INSTALL

STEP 11

SEE FIGURES 20 - 22

11) Put into place the LED Light Bar and position it at Vehicle's Roof Level in between the ZROADZ Mounting Brackets.

Secure LED Light Bar using the provided T-40 Torx Anti-Theft Screws and the 5/16" Flat Washers



FIG 20

STEP 12

12) Go over and tighten all hardware. Secure all LED Light Power Wires and connect harness.

STEP 13

13) ZROADZ recommends LED Lights be wired with ZROADZ harness kit (part# Z390020S-A) or by utilizing a compatible custom wiring harness. Wiring must be installed by competent & knowledgeable automotive electrician.



FIG 21

STEP 14

ADJUSTMENT TIPS

14) To adjust the angle of your Light Bar, rotate the LED(s) to adjust the angles till your desired light pattern is reached. There will be minimal adjustment due to curved light bar orientation. You may then tighten the hardware and secure everything in place. Be careful not to over tighten the mounting hardware.

It is best to adjust the angle with the vehicle on level ground with lights facing a wall, garage door or other solid barrier. We recommend checking from a distance of 25'. Your installation is now completed.



FIG 22

LED LIGHT BRACKET INSTALLATION - PROCESS COMPLETE



ZROADZ

DYNAMIC LED MOUNTING SOLUTIONS

ZROADZ PRODUCT WARRANTY

ZROADZ PRODUCT WARRANTY

ZROADZ warrants its grille products to be free from defects in material and workmanship for the lifetime of the grille. ZROADZ warrants the finish of its grille products for a 3 year period beginning at the time of sale to the end user. These warranties are limited warranties and do not cover abuse, modification or improper installation nor do they cover finish failure caused by caustic cleaning agents, road salts or other chemicals. ZROADZ reserves the right to repair or replace a defective product at its sole discretion. Any ZROADZ product must be returned to ZROADZ for warranty consideration and must be returned at the customer's expense. In the event that the product is deemed to be defective, the repaired or replaced item will be returned via a surface shipping method to the customer at ZROADZ expense. No provision is made for any labor, rental car or other costs incurred by the failure of its products.

LED LIGHTING EQUIPMENT INSTALLATION / DISCLAIMER

WARNING

PLEASE CONSULT YOUR LOCAL AUTOMOTIVE ELECTRICAL PROFESSIONAL FOR INSTALLATION SERVICES AND ADVICE. ZROADZ IS ONLY EQUIPPED TO PROVIDE BASIC TECHNICAL ASSISTANCE DUE TO THE DIVERSITY OF VEHICLES, VEHICLE OPTIONS & MODIFICATIONS AND LIGHTING CONFIGURATION OPTIONS AVAILABLE. ZROADZ cannot be held liable due to improper component installation and / or faulty wiring.

GENERAL GUIDELINES

LED Lights & LED Light Bars operate at relatively high currents and should only be installed by qualified personnel with experience in switched / relayed high draw DC Circuits.

- Light Bars are designed for use only with standard 12v DC power systems
- Light Bars are for OFF-ROAD USE ONLY. Check your local laws & regulations regarding vehicle mounted lights.
- Some Light Bars are equipped with waterproof connectors while others are simply pig-tailed
- Red Wires = POSITIVE | Black Wires = NEGATIVE
- ALWAYS install your lights on a fused circuit. Basic fusing guidelines: maximum 5A for every 10" of LED Light Bar.

GENERAL USE, INSTALL AND ADJUSTMENT TIPS

NOTE 1: ZROADZ LED Light Bars themselves are for OFF-ROAD USE ONLY.

NOTE 2: Light Bars depending on the configuration of your vehicle and its options and/or modifications may need to be adjusted for appropriate beam projection. To adjust the angle of your light bars simply loosen the mounting hardware on either side of each Light Bar, rotate the Light Bar to adjust the angle, then tighten the hardware once the desired angle is achieved (please be careful not to over-tighten the mounting hardware or scratch the protective powder-coat finish). It is best to adjust the angle with the vehicle on level ground with the lights facing a wall, garage door or other solid barrier at a distance of approximately 25-30 feet.

NOTE 3: Please consult a qualified automotive electrical professional for light bar wiring installation.

NOTE 4: An optional universal wiring harness (part# Z390029S-A) is also available that includes high-heat & oil/fuel resistant wires, waterproof connector, 12v relay, 12v rocker switch, inline fuse holder. Our universal wiring harness significantly expedites the installation process but is not a vehicles specific "Plug & Play" product and does not eliminate the need for a professional installation.

Please contact your local ZROADZ dealer for more information or visit www.zroadz.com.

PRODUCT CARE INFORMATION

PRODUCT CARE INFORMATION

Wash regularly as you would when caring for your vehicles. Never use dish soap. Never leave wet water spots as that may leave a blemish.

MATTE BLACK FINISH

Paint warranty applies to defects in material and / or workmanship, it does not cover the matte finish surface appearance.

To enjoy the matte appearance for many years to come, please follow these owner care and maintenance tips.

Get a no-shine matte car wash soap that uses no fillers, no silicone, and won't strip your matte paint of its layer of protection.

Do not use wax, detail spray, armorall®, or any products made for normal paint. Use only products specifically developed for matte finish paint. Do not use products that are even mildly abrasive, such as polishes, glazes, or rubbing compounds. Do not use mechanical cleaners or polishers. Do not use terrycloth, cloth, or paper towels. Do not rub the finish vigorously, this will burnish the paint finish, causing a permanent shiny spot. Shiny spots cannot be removed.

Do not use commercial car wash facilities or their shine enhancement products. Most car wash brushes, large mechanized "towels," and shine enhancement products can damage matte paint.

Remove foreign substances such as insect remains, tar, and road debris using a soft applicator and a mild solvent; saturate and soak area before cleaning—rub lightly.

Hand-wash with a soft wash mitt and mild cleaning product safe for matte paint. Use microfiber cleaning cloths with alcohol-based window cleaner for basic surface clean-up.

GLOSS BLACK FINISH

ZROADZ with Gloss Black Powder Coated Finish may be washed regularly as you would when caring for your vehicles finish using soap and water. ZROADZ should be waxed at the same time that you wax the vehicle. As a general rule, anything you use to clean your vehicles painted surfaces can be used to clean and maintain your ZROADZ grille. A Gloss powder Coated Finish can be cared for in the same fashion that you would care for your vehicles factory paint job. Never leave wet water spots as that may leave a blemish.

PARTS ARE PATENT PENDING. ALL RIGHTS RESERVED - COPYRIGHT ©2016 - ZROADZ LED, INC.