



ZROADZ

DYNAMIC LED MOUNTING SOLUTIONS



PROFESSIONAL INSTALL RECOMMENDED

2017 FORD F-250 / F-350

PART#: Z335471 / Z335471-KIT-C

FRONT ROOF LED LIGHT MOUNTS

PARTS ARE PATENT PENDING. ALL RIGHTS RESERVED - COPYRIGHT ©2017 - ZROADZ LED, INC.

PARTS INCLUDED

- (1) - Driver Side Roof Mount Upright
- (1) - Passenger Side Roof Mount Upright
- (1) - Driver Side Curved Coupler
- (1) - Passenger Side Curved Coupler
- (1) - Driver Side Straight Coupler
- (1) - Passenger Side Straight Coupler
- (1) - Hardware Pack



* Simulated Rendering, Not actual parts.

LED LIGHTS INCLUDED

Z335471 - No LED Lights Included

Z335471-KIT-C - (1) ZROADZ 52" Curved LED Light Bar

HARDWARE INCLUDED

Z335471

- (1) - Weather Proof Rubber Boot
- (1) - 3/16 DIA. Wire Clip Mount
- (2) - 1/2 x 20 Hex Nut
- (2) - 1/2 Split Lock Washer
- (8) - 10-32 x .625 Button Head Allen Cap Stainless Steel Screws
- (8) - 10/32 Nylock Stainless Steel Nuts
- (11) - M5 Hex Bolts
- (11) - M5 Washers
- (2) - Moulding Plates
- (1) - Driver Side Bottom Plate Gasket
- (1) - Passenger Side Bottom Plate Gasket

Z335471-KIT-C

- (1) - Weather Proof Rubber Boot
- (1) - 3/16 DIA. Wire Clip Mount
- (2) - 1/2 x 20 Hex Nut
- (2) - 1/2 Split Lock Washer
- (8) - 10-32 x .625 Button Head Allen Cap Stainless Steel Screws
- (8) - 10/32 Nylock Stainless Steel Nuts
- (11) - M5 Hex Bolts
- (11) - M5 Washers
- (2) - Moulding Plates
- (1) - Driver Side Bottom Plate Gasket
- (1) - Passenger Side Bottom Plate Gasket
- (1) - Torx Bit T-40
- (2) - M8 Tamper Proof Bolt
- (2) - M8 Split Lock Washer

TOOLS REQUIRED

- Drill & Tapered Drill Bit
- Air Hose & Nozzle
- Alcohol Cleaning Solution
- Cleaning Rag
- Socket Set & Ratchet Tool
- Ratchet Extensions
- Various Wrenches
- Dikes or Snips
- Torq Bit Set
- Heat Gun

MATERIALS NEEDED - Clear RTV Silicone
- 1/2" x 1/4" DIA Shrink Tube

INSTALLATION GUIDE

START HERE

PLEASE READ AND UNDERSTAND ALL INSTRUCTIONS BEFORE INSTALLATION. Auto makers offer varied models to each vehicle and occasionally manufacture more than one body style of the same model. To assure your part is correct; our tech department can be contacted at orders@zroadz.com to verify fitment and assist with technical questions. All other inquires can be directed to orders@zroadz.com. In the event you do not have internet access please call 844-653-8040

* APPLICATION MODELS VARY. WE RECOMMEND TO VERIFY FITMENT BEFORE BEGINNING INSTALLATION PROCESS.
* IMAGES FEATURED IN THE INSTRUCTION DOCUMENTS MAY NOT ALWAYS EXACTLY MATCH YOUR MODEL OR PART.

BEFORE YOU BEGIN

LED LIGHT BRACKET INSTALLATION

IMPORTANT NOTE: The installation requires additional cutting and removal of material inside vehicle cab. The A-Pillar Air Bag will also need to be dropped and pushed aside. If you are not comfortable with this, stop installation and consult a professional.

START HERE: Turn off engine, chalk tires with stop block, open the hood and disconnect the battery.

STEP 1

1) First, Clean the base of the supplied roof brackets with alcohol. Apply the provided bottom plate gaskets.



FIG 1

STEP 2

SEE FIGURES 2 & 3

2) Make sure to align the gaskets so that the holes, down tube, and front square opening are properly fitted with base plate to gasket.

Note there is a left side gasket and a right side gasket.



FIG 2

FIG 3



ZROADZ

DYNAMIC LED MOUNTING SOLUTIONS

ROOF MOUNT INSTALLATION - CONTINUED

PARTS ARE PATENT PENDING. ALL RIGHTS RESERVED - COPYRIGHT ©2017 - ZROADZ LED, INC.



FIG 4



FIG 5

STEP 3

3) The ZROADZ Brackets have distinguished Passenger Side and Driver Side Uprights and could be noted by the brushed aluminum interior plate. The outside features the black powder coated steel plate with Logo Markings.

STEP 4

SEE FIGURE 5

4) Remove exterior trim piece that covers the vehicle cab seam to side.



FIG 6

REMOVE TRIM PIECE



FIG 7

STEP 4

SEE FIGURE 6

4) Start from the rear of the cab where the trim piece clips to a button.

STEP 5

SEE FIGURES 7-8-9

5) Gently pull the fastener loose and continue pry up and forward all the way to the front.

Note the very front of the vehicle cab is a forward facing tab the holds the trim piece down from the front.

Perform this step for both sides of the roof.



FIG 8



FIG 9

LED LIGHT ROOF MOUNT INSTALLATION - CONTINUED



ROOF MOUNT INSTALLATION - CONTINUED

PARTS ARE PATENT PENDING. ALL RIGHTS RESERVED - COPYRIGHT ©2017 - ZROADZ LED, INC.



FIG 10



FIG 11

STEP 6

SEE FIGURE 10

6) AT this point you will need to drop the interior roof upholstery.

INSTALLERS NOTE

This is a necessary and important step so that you can temporarily drop and push to the side the air bags and any other critical equipment stuffed up in between roof cab and the interior which will ensure critical components are not damaged.

STEP 7

SEE FIGURES 11 - 12

7) 2017 Ford F-250 / F-350 model vehicles feature an aluminum cab structure that is bolted together at the roof seam.

Starting on the Driver Side at the windshield and working your way backwards, remove first (6) bolts.



FIG 12

FIT ROOF MOUNT BRACKET



FIG 13

STEP 8

SEE FIGURES 13 - 14

8) Referencing Figure #13, note the Driver Side Upright and the down tube location will align with the vehicle cab bolt hole #2. Use the tapered drill bit and bore out the bolt hole to a final diameter of 1/2" and just enough so that the down tube nub will fit snugly in place.

NOTE: No Drilling is required on the Vehicle Cab's Passenger Side.



FIG 14

STEPS 9 & 10

SEE FIGURES 15 - 16

9) With the hole drilled through, clean off all drilling debris and flash INSIDE AND OUTSIDE OF THE DRILL HOLE LOCATIONS. This is a very important to create a flush sealing surface and you do not want to leave any chance of rust occurring.

10) Put into place the Bracket Mount Upright and slip the bracket under the tab as seen in Figure #16.



FIG 15



FIG 16

LED LIGHT ROOF MOUNT INSTALLATION - CONTINUED



ROOF MOUNT INSTALLATION - CONTINUED

PARTS ARE PATENT PENDING. ALL RIGHTS RESERVED - COPYRIGHT ©2017- ZROADZ LED, INC.



STEP 11

SEE FIGURE 17

11) Double check the Bracket Mount is properly positioned and aligned with the vehicle cab bolt holes.

Once confirmed, dab a thin layer of clear RTV Silicone in and around the outside of each hole to help with weather proofing and sealing.

STEP 12

SEE FIGURE 18

12) Proceed with securing the Bracket Mounts to Vehicle Cab by placing the provided Hex Bolts and Washers into position (exposed Vehicle Cab Bolt Holes).



CUT DOWN ROOF EXTERIOR TRIM PIECE

STEP 13

SEE FIGURE 19

13) Tighten down each Hex Bolt w/ Washer. Start at the front and then move to the back working your way towards the middle.

NOTE: Leave the last Hex Bolt somewhat loose to allow for Step # 15 to be completed.



STEPS 14 & 15

SEE FIGURES 20-22

14) Take the Vehicle's Exterior Trim Piece and hover it close to where the ZROADZ Bracket Mount Bottom Plate ends. Mark the Trim Piece so that when it is cut down, the Trim will fit back down into the Roof Channel.

15) Carefully and cleanly cut down the Trim Piece and then insert the provided Moulding Plate into position as seen in Figure #22.

Put into position the Exterior Trim Piece so that it is secured under the Moulding Plate and re-attach all the fasteners.

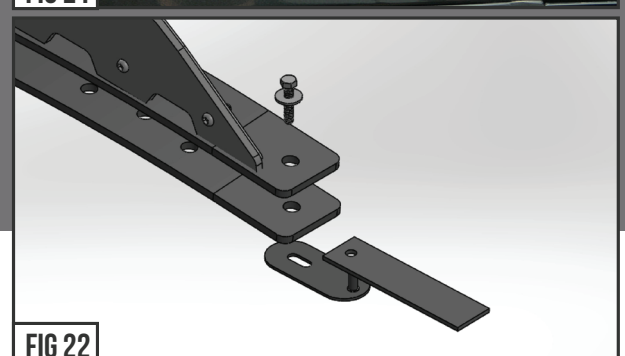
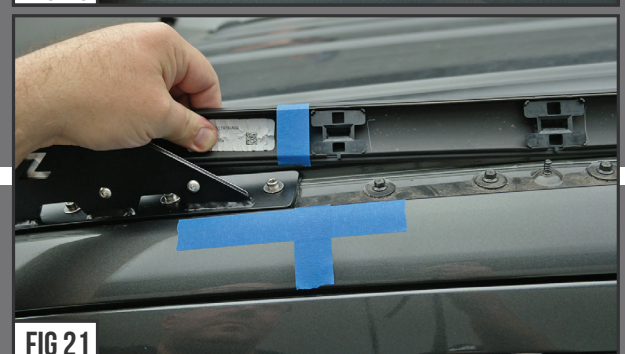

LED LIGHT ROOF MOUNT INSTALLATION - CONTINUED



ROOF MOUNT INSTALLATION - CONTINUED

PARTS ARE PATENT PENDING. ALL RIGHTS RESERVED - COPYRIGHT ©2017 - ZROADZ LED, INC.



STEP 16

16) Obtain the supplied security torx, lock washer and tool bit from the hardware pack.

STEP 17

17) With a friend's help, install the 52" light to the brackets with the wire on the drivers side.

SEE FIGURES 23 - 25



LED LIGHT INSTALL

STEP 18

18) Tighten hardware by giving the torx bit some extra leverage.

SEE FIGURE 28



STEPS 19

19) Secure the wire to the driver bracket with supplied wire clip and nut. Leave slack in the wire from LED to the wire clip for some movement & available adjustment.

SEE FIGURE 29





ROOF MOUNT INSTALLATION - CONTINUED

PARTS ARE PATENT PENDING. ALL RIGHTS RESERVED - COPYRIGHT ©2017 - ZROADZ LED, INC.

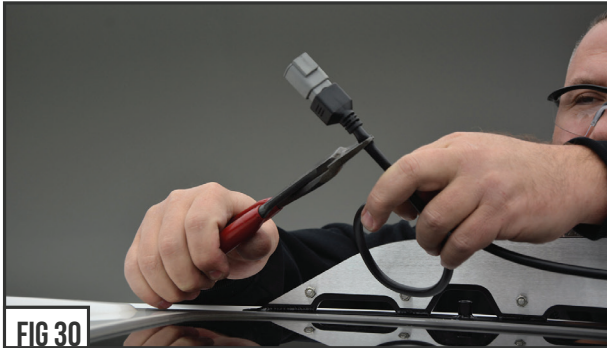

FIG 30

STEPS 20

SEE FIGURE 30

20) Cut the LED light wires. Leave enough room for the insulation to be removed and the red and black wires to pass through the roof via the "Through Bolt Down Tube".



FIG 31

STEP 21

SEE FIGURE 31

21) Trim back a large amount of the insulation sheath off the LED Wires so that you can slip them through the rubber weather proofing boot.

To expose the wires, a sharp razor could easily splice open the insulation sheath.

WIRING PLUMBING



FIG 32

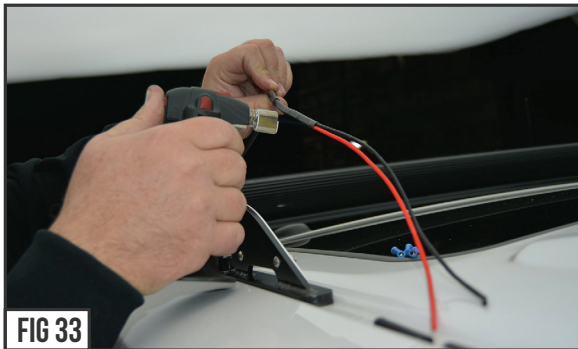

FIG 33

STEPS 22

SEE FIGURES 32 & 33

22) Install 1/4" heat shrink insulation over wires as shown in Figure #32. Shrink insulation with heat gun or similar.



FIG 34

STEPS 23

SEE FIGURES 34 - 36

23) Use a 50/50 mix of dish soap and water solution to install supplied boot over wire as shown in Figure #36.

Pass the wire through the tube. Use a liberal amount of solution on the bracket around the area where the boot installs to aid in slipping the boot over the post.

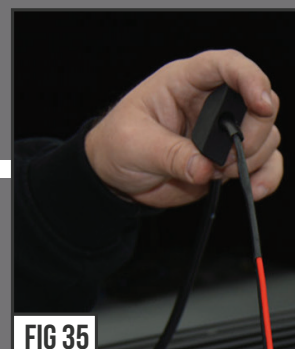

FIG 35



FIG 36



FIG 37



ZROADZ

DYNAMIC LED MOUNTING SOLUTIONS

ROOF MOUNT INSTALLATION - CONTINUED

PARTS ARE PATENT PENDING. ALL RIGHTS RESERVED - COPYRIGHT ©2017 - ZROADZ LED, INC.



FIG 38



FIG 39

STEPS 24

SEE FIGURE 38

24) Stuff the boot into the bracket opening and over the down tube upright.

STEP 25

SEE FIGURES 39 - 41

26) With the rubber boot fully seated (as seen in Figures #40 & #41) you are now ready to finish wiring up the LED Light bar to a wiring harness.

After wiring is complete, re-install vehicle's interior in the reverse order it was removed according to industry "R&R" method.

FINAL INSTALLATION



FIG 40



FIG 41

STEP 20

20) Wire LED Light with a ZROADZ optional wiring harness kit (part# Z390020S-A) or by utilizing a compatible custom wiring harness. ZROADZ recommends LED Lights be wired with ZROADZ harness kit (part# Z390020S-A).



FIG 42

STEPS 18

ADJUSTMENT TIPS

21) To adjust the angle of your Light Bar, rotate the LED(s) to adjust the angles till your desired light pattern is reached. There will be minimal adjustment due to curved light bar orientation. You may then tighten the hardware and secure everything into place. Be careful not to over tighten the mounting hardware.

It is best to adjust the angle with the vehicle on level ground with lights facing a wall, garage door or other solid barrier. We recommend checking from a distance of 25'. Your installation is now completed.

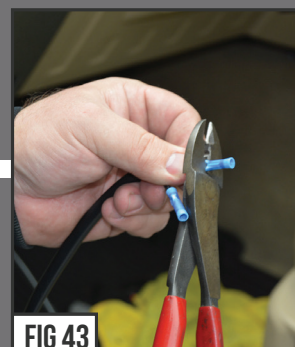

FIG 43

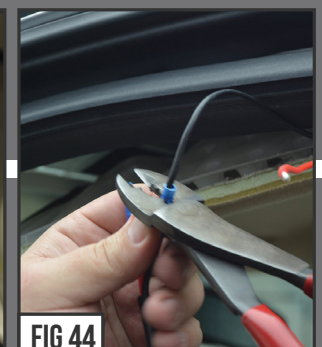

FIG 44

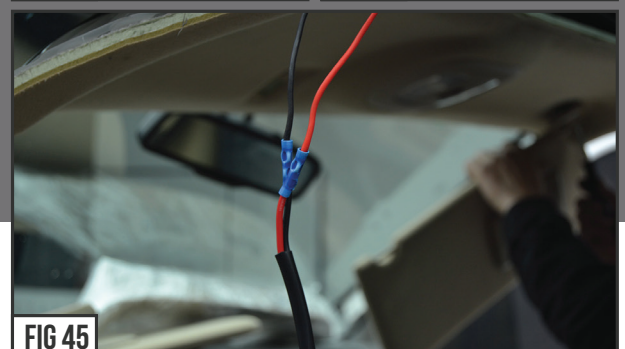

FIG 45

LED LIGHT ROOF MOUNT INSTALLATION - COMPLETE



ZROADZ

DYNAMIC LED MOUNTING SOLUTIONS

ZROADZ PRODUCT WARRANTY

ZROADZ PRODUCT WARRANTY

ZROADZ warrants its grille products to be free from defects in material and workmanship for the lifetime of the grille. ZROADZ warrants the finish of its grille products for a 3 year period beginning at the time of sale to the end user. These warranties are limited warranties and do not cover abuse, modification or improper installation nor do they cover finish failure caused by caustic cleaning agents, road salts or other chemicals. ZROADZ reserves the right to repair or replace a defective product at its sole discretion. Any ZROADZ product must be returned to ZROADZ for warranty consideration and must be returned at the customer's expense. In the event that the product is deemed to be defective, the repaired or replaced item will be returned via a surface shipping method to the customer at ZROADZ expense. No provision is made for any labor, rental car or other costs incurred by the failure of its products.

LED LIGHTING EQUIPMENT INSTALLATION / DISCLAIMER

WARNING

PLEASE CONSULT YOUR LOCAL AUTOMOTIVE ELECTRICAL PROFESSIONAL FOR INSTALLATION SERVICES AND ADVICE. ZROADZ IS ONLY EQUIPPED TO PROVIDE BASIC TECHNICAL ASSISTANCE DUE TO THE DIVERSITY OF VEHICLES, VEHICLE OPTIONS & MODIFICATIONS AND LIGHTING CONFIGURATION OPTIONS AVAILABLE. ZROADZ cannot be held liable due to improper component installation and / or faulty wiring.

GENERAL GUIDELINES

LED Lights & LED Light Bars operate at relatively high currents and should only be installed by qualified personnel with experience in switched / relayed high draw DC Circuits.

- Light Bars are designed for use only with standard 12v DC power systems
- Light Bars are for OFF-ROAD USE ONLY. Check your local laws & regulations regarding vehicle mounted lights.
- Some Light Bars are equipped with waterproof connectors while others are simply pig-tailed
- Red Wires = POSITIVE | Black Wires = NEGATIVE
- ALWAYS install your lights on a fused circuit. Basic fusing guidelines: maximum 5A for every 10" of LED Light Bar.

GENERAL USE, INSTALL AND ADJUSTMENT TIPS

NOTE 1: ZROADZ LED Light Bars themselves are for OFF-ROAD USE ONLY.

NOTE 2: Light Bars depending on the configuration of your vehicle and its options and/or modifications may need to be adjusted for appropriate beam projection. To adjust the angle of your light bars simply loosen the mounting hardware on either side of each Light Bar, rotate the Light Bar to adjust the angle, then tighten the hardware once the desired angle is achieved (please be careful not to over-tighten the mounting hardware or scratch the protective powder-coat finish). It is best to adjust the angle with the vehicle on level ground with the lights facing a wall, garage door or other solid barrier at a distance of approximately 25-30 feet.

NOTE 3: Please consult a qualified automotive electrical professional for light bar wiring installation.

NOTE 4: An optional universal wiring harness (part# Z390029S-A) is also available that includes high-heat & oil/fuel resistant wires, waterproof connector, 12v relay, 12v rocker switch, inline fuse holder. Our universal wiring harness significantly expedites the installation process but is not a vehicles specific "Plug & Play" product and does not eliminate the need for a professional installation.

Please contact your local ZROADZ dealer for more information or visit www.zroadz.com.

PRODUCT CARE INFORMATION

PRODUCT CARE INFORMATION

Wash regularly as you would when caring for your vehicles. Never use dish soap. Never leave wet water spots as that may leave a blemish.

MATTE BLACK FINISH

Paint warranty applies to defects in material and / or workmanship, it does not cover the matte finish surface appearance.

To enjoy the matte appearance for many years to come, please follow these owner care and maintenance tips.

Get a no-shine matte car wash soap that uses no fillers, no silicone, and won't strip your matte paint of its layer of protection.

Do not use wax, detail spray, armorall®, or any products made for normal paint. Use only products specifically developed for matte finish paint. Do not use products that are even mildly abrasive, such as polishes, glazes, or rubbing compounds. Do not use mechanical cleaners or polishers. Do not use terrycloth, cloth, or paper towels. Do not rub the finish vigorously, this will burnish the paint finish, causing a permanent shiny spot. Shiny spots cannot be removed.

Do not use commercial car wash facilities or their shine enhancement products. Most car wash brushes, large mechanized "towels," and shine enhancement products can damage matte paint.

Remove foreign substances such as insect remains, tar, and road debris using a soft applicator and a mild solvent; saturate and soak area before cleaning—rub lightly.

Hand-wash with a soft wash mitt and mild cleaning product safe for matte paint. Use microfiber cleaning cloths with alcohol-based window cleaner for basic surface clean-up.

GLOSS BLACK FINISH

ZROADZ with Gloss Black Powder Coated Finish may be washed regularly as you would when caring for your vehicles finish using soap and water. ZROADZ should be waxed at the same time that you wax the vehicle. As a general rule, anything you use to clean your vehicles painted surfaces can be used to clean and maintain your ZROADZ grille. A Gloss powder Coated Finish can be cared for in the same fashion that you would care for your vehicles factory paint job. Never leave wet water spots as that may leave a blemish.

PARTS ARE PATENT PENDING. ALL RIGHTS RESERVED - COPYRIGHT ©2016 - ZROADZ LED, INC.