



**DIRECT-REPLACEMENT
INSTALLATION GUIDE**

GM 1500 (2019-ON)

FACTORY RACE SERIES 3.0 INTERNAL BYPASS

883-06-175 - Kit: 19-ON GM 1500 Front Coilover, Internal Bypass, 3.0 Series, Recirc R/R, DSC, Non-TB/Non-AT4 3.5" Lift, TB/AT4 1.5" Lift

883-26-105 - Kit: 19-ON GM 1500, Rear, Internal Bypass, 3.0 Series, Recirc R/R, DSC, Non-TB/Non-AT4 2-3" Lift, TB/AT4 0-1" Lift

CONTENTS

INTRODUCTION	1
SUPPLIED PARTS	2
SHOCK DIAGRAM	3
SAFETY INSTRUCTIONS	4
INSTALLATION GUIDELINES	5
FRONT SHOCK INSTALLATION	6
REAR SHOCK INSTALLATION	13
FOX FACTORY DSC	19
WARRANTY INFORMATION	20
SHOCKS NEED LOVE TOO	21

INTRODUCTION

Thank you for choosing FOX direct-replacement shocks for your vehicle. FOX products are designed, tested, and manufactured by the finest professionals in the industry.

FOX recommends that you become completely familiar with the handling characteristics of your modified vehicle before operating it under rigorous conditions, helping to avoid potential rollover situations and other loss of control events. FOX further recommends that you use appropriate protective equipment at all times when operating your vehicle.

To achieve the best performance and product longevity, periodic service and maintenance is required. Please refer to the Service and Upgrades section for more information.

IN THE BOX

- Front Shocks or Rear Shocks
- Supplied Hardware
- Installation Guide

SUPPLIED PARTS

SHOCK ASSEMBLY				
FOX PN	DESCRIPTION		QTY	NOTES
983-06-175-L	FRONT, LEFT COIL-OVER		1	Non-TB/Non-AT4 3.5" Lift, TB/AT4 1.5" Lift
983-06-175-R	FRONT, RIGHT COIL-OVER		1	
983-26-105	REAR, LEFT SHOCK		1	Non-TB/Non-AT4 2-3" Lift, TB/AT4 0-1" Lift
983-26-106	REAR, RIGHT SHOCK		1	
FRONT RESERVOIR MOUNTING ASSEMBLY				
FOX PN	DESCRIPTION	*HARDWARE REF.	QTY	NOTES
026-01-210-1	LEFT FRONT RESERVOIR BRACKET	B1	1	Brackets mount the remote reservoirs to the vehicle.
026-01-210-2	RIGHT FRONT RESERVOIR BRACKET	B2	1	
803-02-127	MOUNTING HARDWARE	C1	1	The nuts, bolts, and washers mount reservoir brackets to the vehicle's frame of Non-TB/NonAT4 models only.
018-02-044	HEX SCREW: 1/4-20 X .75	D1	4	The hex screw tightens the reservoir clamp nut against the dovetail notches and bracket to secure the reservoir.
026-01-184	RESERVOIR CLAMP NUT	D2	4	
803-02-097	HOSE SEPARATOR KIT	E1	2	Each kit is includes a bottom and top hose separator. The two components are clamped together with the supplied screw.
REAR RESERVOIR MOUNTING ASSEMBLY				
FOX PN	DESCRIPTION	*HARDWARE REF.	QTY	NOTES
026-01-211	REAR RESERVOIR BRACKET	F1	2	Brackets mount the remote reservoirs to the vehicle.
018-04-012-A	SELF TAPPING SCREW: 3/8-12 X .75	G1	4	The screws mount the reservoir brackets to the vehicle's frame.
018-02-044	HEX SCREW: 1/4-20 X .75	D1	4	The hex screw tightens the reservoir clamp nut against the dovetail notches and bracket to secure the reservoir.
026-01-184	RESERVOIR CLAMP NUT	D2	4	
803-02-123	REAR HOSE P-CLAMP	H1	2	Each P-Clamp includes a bolt, washer, lock nut, and loop clamp.

*Hardware Reference is used throughout the installation manual to provide notation of the supplied kit.

SHOCK DIAGRAM

FRONT COIL-OVER

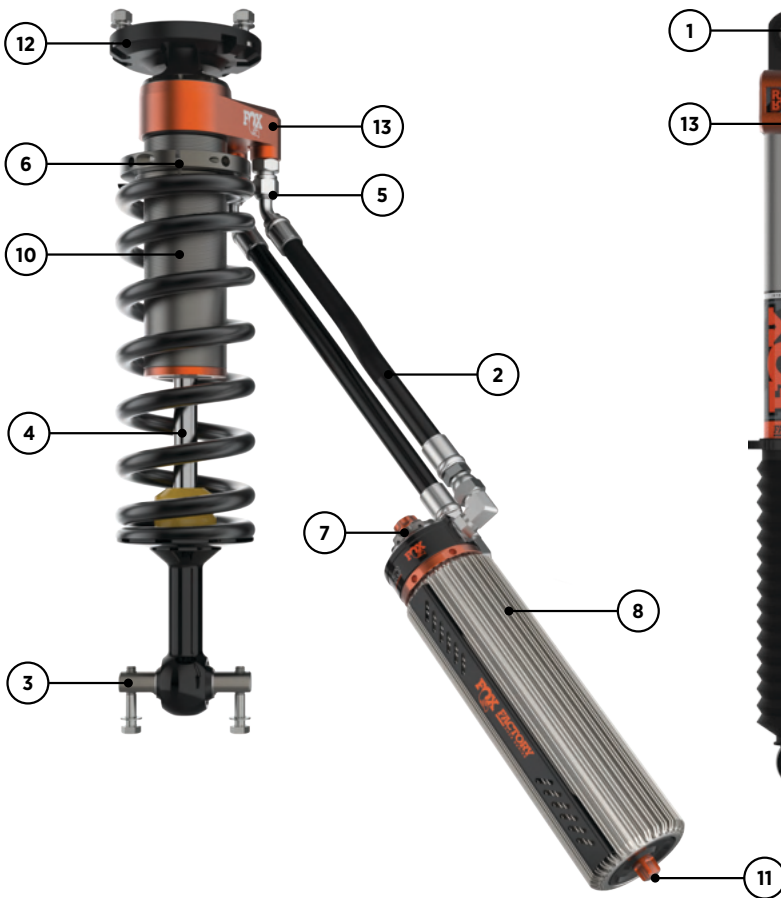

REAR SHOCK

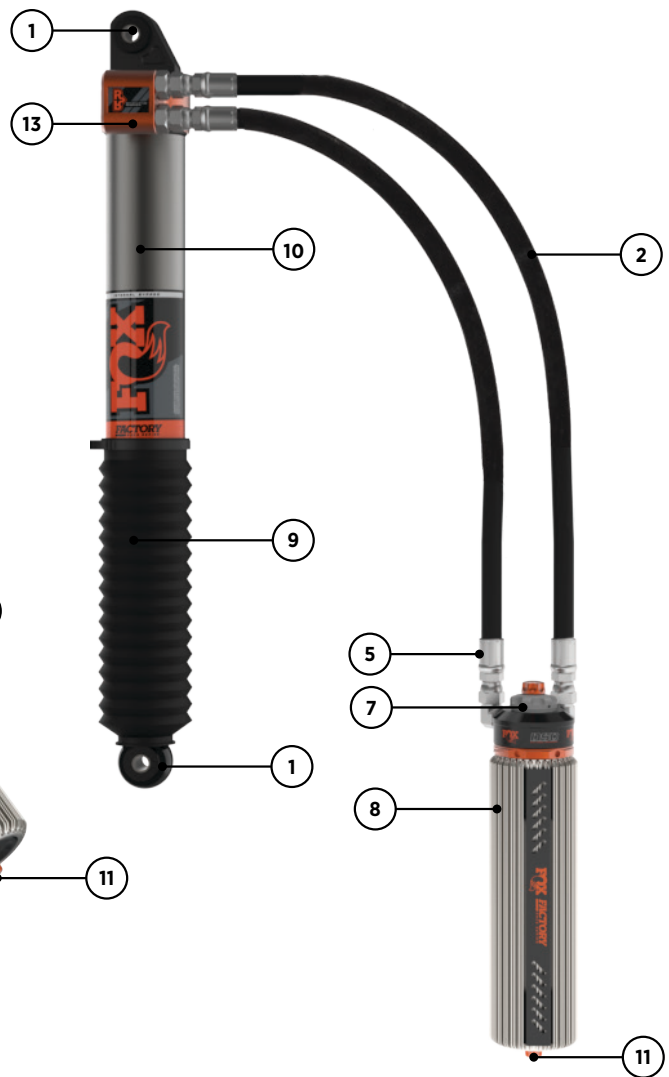

PART NO.	NAME	PART NO.	NAME
1	Eyelet	8	Reservoir
2	Hose	9	Shaft guard
3	Bar-pin bolt	10	Shock body
4	Shaft	11	Schrader valve
5	Hose fitting	12	Top hat
6	Preload ring	13	Reservoir bridge
7	DSC adjuster		

WARNING

SAFETY INSTRUCTIONS

- FOX direct-replacement shocks are designed to fit and allow proper clearance with the stock suspension. If aftermarket suspension components are installed it is the customer's responsibility to ensure that interference between the FOX shocks and other vehicle components does not occur at any point in the shock stroke.
- FOX direct-replacement shocks should always be installed as a set for maximum performance.
- Proper installation and service procedures are essential for the safe and reliable operation of the suspension components, requiring the experience and tools specially designed for this purpose. Installation and maintenance procedures for this product must be performed by a qualified service technician, to avoid potentially unsafe vehicle handling characteristics, which may result in **SERIOUS INJURY** or **DEATH**.
- Modifying your vehicle's suspension will change the handling characteristics of your vehicle. Under certain conditions, your modified vehicle may be more susceptible to loss of control or rollover, which can result in **SERIOUS INJURY** or **DEATH**. Thoroughly familiarize yourself with the modified vehicle handling characteristics before any rigorous vehicle operation. Wear protective body gear and a helmet when appropriate. Installation of vehicle roll bars or cage is highly recommended.
- FOX direct-replacement shocks are gas-charged and are highly pressurized. Placing shocks in a vise or clamp, applying heat, or attempting to open or service the shock without the proper tools and training can result in **SERIOUS INJURY** or **DEATH**. Do not attempt to modify, puncture or incinerate a FOX direct-replacement shock absorber.
- Any attempt to misuse, misapply, modify, or tamper with any FOX product voids any warranty and may result in **SERIOUS INJURY** or **DEATH**.

WARNING

INSTALLATION GUIDELINES

- Always use a chassis lift for the installation of shocks, and make certain that the raised vehicle is securely attached to the lift to prevent the vehicle from slipping, falling, or moving during the installation process.
- DO NOT install any FOX product without the necessary special tools, expertise and chassis lift or you will subject yourself to the risk of SERIOUS INJURY or DEATH. If you elect to not use a chassis lift (which may result in SERIOUS INJURY or DEATH), ensure that the vehicle is: (1) on level ground, (2) that all tires on the ground during installation are blocked to prevent vehicle movement, (3) that at least two tires are on the ground at all times, and (4) that adequately secured jack stands are used to support the vehicle. NEVER get under the vehicle until you have checked to ensure that the vehicle will be stable during installation.
- FOX direct-replacement shocks are designed to fit your vehicle's shock mounts without modification except the reservoir placement on specific models and applications.
- If a preload adjustment is necessary for your application DO NOT adjust preload with the coil-over on the vehicle. Remove the coil-over from the vehicle and use a spring compressor to remove the lower spring hardware and spring. Once the spring is removed, you can adjust the preload ring. DO NOT Exceed more the 1/2" of additional preload. If more than 1/2" of preload is required, you will need to go up in spring rate or get a longer spring that fits the application.

FRONT SHOCK INSTALLATION

NOTICE: Medium-strength thread-lock is recommended on all bolts.

1. Please read the installation guidelines on page 5 for instructions on how to lift and secure the vehicle.
2. Record the front vehicle ride height to ensure the proper lift is attained after kit is installed. READ INSTALLATION GUIDELINES ON HOW TO PROPERLY ADJUST PRELOAD.

STOCK SHOCK REMOVAL

3. Remove both front wheels from the vehicle.
4. Disconnect the brake line and ABS brackets from the upright (Fig. 1 & 2).



Fig. 1: Brake line bracket.



Fig. 2: ABS bracket.

5. Separate the sway bar end link from both steering knuckles (Fig. 3).

6. Detach the tie rod end link at the spindle steering arm (Fig. 4).

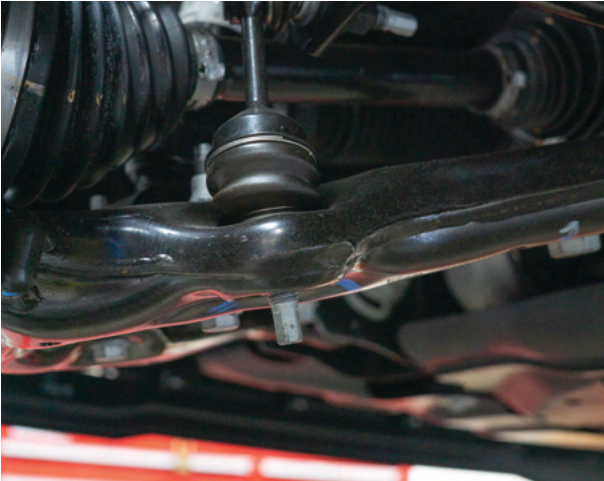

Fig. 3: Sway bar end link.



Fig. 4: Tie rod end link.

7. Loosen the nut connecting the upper control arm (UCA) to the upright. Tap the ball joint stem with a hammer to break it free. Support the lower control arm with a jack stand and remove the UCA's nut. Proceed with caution the UCA has spring tension (Fig. 5).

8. Support the lower control arm with a jack and remove the bar-pin bolts connecting the stock coil-over to the lower control arm (Fig. 6).



Fig. 5: Separate the UCA and upright.



Fig. 6: Remove the bar-pin bolts.

9. Disconnect the electrical harness clips on top of the coil bucket.

10. Remove the three top hat nuts that secure the stock coil-over assembly to the vehicle (Fig. 7). **DO NOT** remove the center nut. Removal of the center nut will release the spring from the stock assembly and may result in **SERIOUS INJURY** or **DEATH!**

11. Take out the stock coil-over assembly (Fig. 8).



Fig. 7: Remove the three top hat nuts.

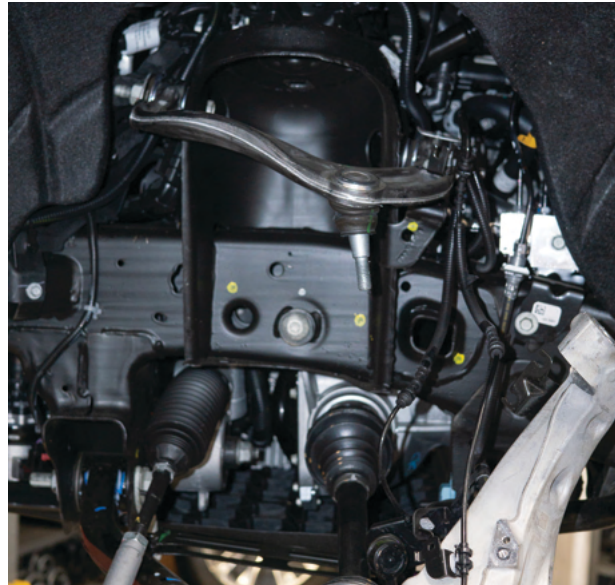

Fig. 8: Take out the stock coil-over assembly.

NOTICE: Do not discard any OEM bolts; many are reused with your new FOX coil-over assembly.

12. Remove the service perch from the coil bucket (Fig. 9). Bend the perch laterally until the metal breaks off (Fig. 10).

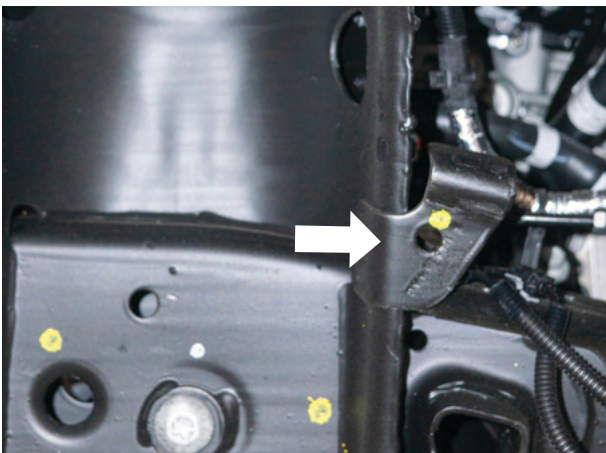

Fig. 9: Remove the service perch.

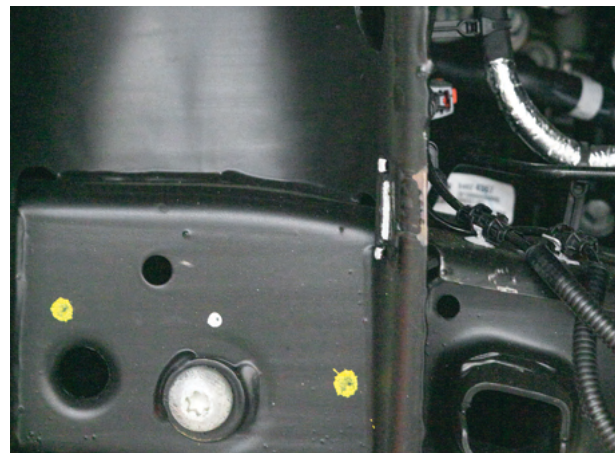

Fig. 10: Bend the perch until it breaks off.

13. An aftermarket UCA is required for all models to install this kit. Install the aftermarket UCA now and follow the company's required specifications. After installation, continue to step 14.

RESERVOIR BRACKET INSTALL

14. For Non-TB/Non-AT4 models, mount the reservoir bracket (B1 & B2) to the vehicle's frame with the supplied hardware (C1). Torque both bolts to 30 ft-lbs. Utilize the holes in the vehicle's frame to locate the hardware (Fig. 11 & 12). For TB/AT4 models, reuse the OEM bolts installed in the vehicle's frame instead of the supplied hardware and torque to OEM specification.



Fig. 11: Use the holes in the vehicles frame.

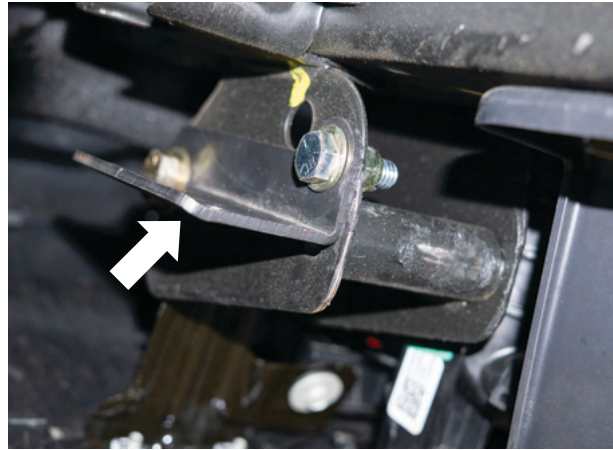

Fig. 12: The bend in the bracket points up.

FOX COIL-OVER INSTALL

15. Install the new coil-over assembly with the reservoir pointed toward the front of the vehicle (Fig. 13). Loosely install the provided bar-pin bolts and top hat nuts.

NOTICE: The coil-over must be oriented so the reservoir bridge and hoses do not contact the coil bucket.

16. Once the coil-over is oriented, torque the top hat nuts to 24 ft-lbs. Torque the bar-pin bolts to 50 ft-lbs.



Fig. 13: Driver's side coil-over assembly is featured.

17. Slide both reservoir clamp nuts (D2) into the upper side of the dovetail notch (Fig. 14).

18. Use the lower side of the dovetail notch on the reservoir to marry the bracket and reservoir (Fig. 15). The reservoir needs at a minimum 1/8" clearance from any surrounding vehicle parts.

19. Once the reservoir is oriented, slide the clamp nut into the dovetail notch from the bottom of the reservoir to the far hole on the reservoir bracket.

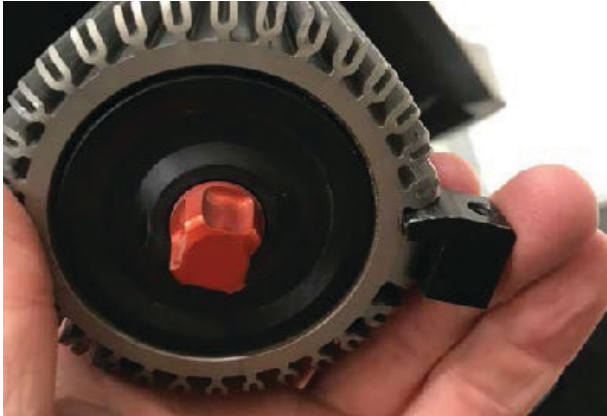

Fig. 14: Slide the clamp nuts into the dovetail.

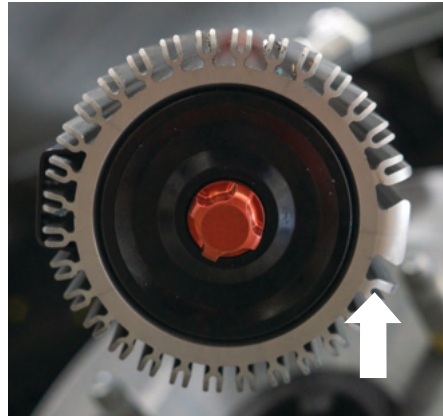

Fig. 15: The lower dovetail marries to the reservoir bracket.

20. Align one of the the clamp nuts with one of the holes in the mounting bracket by sliding it along the upper dovetail notch.

21. The clamp nut and top of the reservoir bracket must be flush. Loosely install one of the supplied screws (D1). Next, slide the second clamp nut to the second hole of the reservoir bracket. Loosely install the second supplied screw. Torque the clamp nut screws to 76 in-lbs. (Fig. 16).



Fig. 16: Fasten the reservoir.

22. Install the supplied hose separator clamp (E1) approximately mid-way on the hose between the reservoir and hose fitting (Fig.17). Use the clamp to improve the hose's clearance from the vehicle. Torque the clamp's screw to 76 in-lbs.

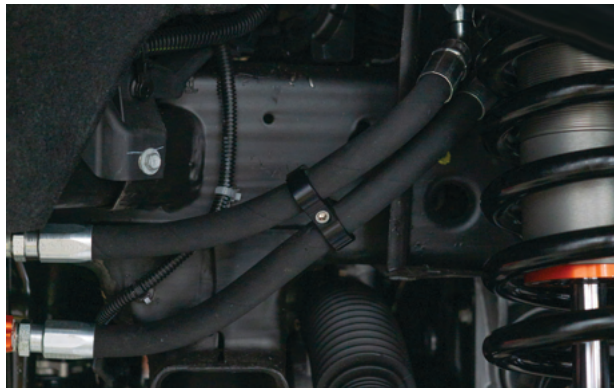

Fig. 17: Hose separator clamps.

23. Reattach the UCA to the upright with the ball joint bolt. Use a pry bar to apply leverage to the UCA and lower it to the upright. Reattach the nut and torque to OEM specification (Fig. 18).



Fig. 18: Reattach UCA to the upright.

24. Reinstall the brake bracket bolt (Fig. 19), ABS bracket bolt (Fig. 20), tie rod end link (Fig. 21), and sway bar end link (Fig. 22). Torque all hardware to OEM specification.



Fig. 19: Brake line bracket.



Fig. 20: ABS bracket.



Fig. 21: Tie rod end link.



Fig. 22: Sway bar end link.

FENDER LINER TRIMMING

NOTICE: Fender liner trimming is optional. The DSC adjusters are still usable with uncut fender liners.

25. Test fit the fender liner and assess how much trimming is required. Draw a cut line on the fender liner.

26. Remove the fender liner and begin with a conservative cut. Repeat test fitting and cutting until the desired appearance is achieved (Fig. 23).

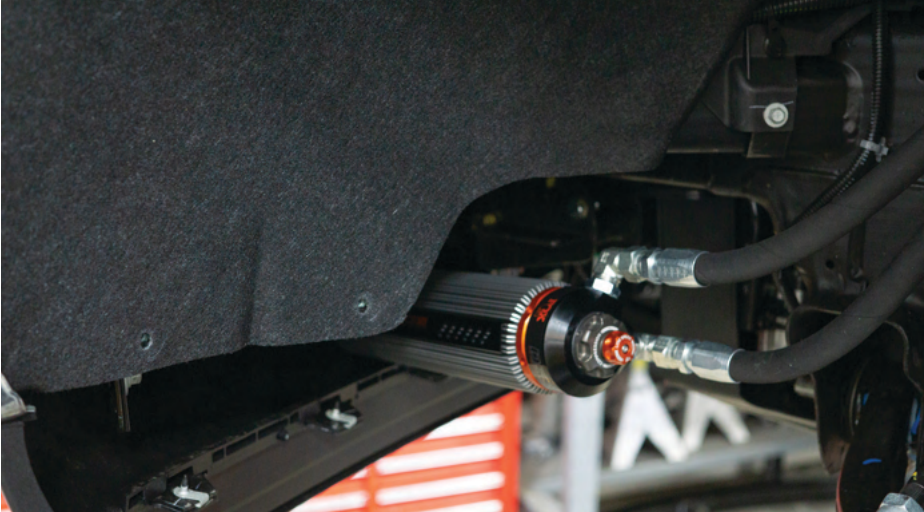

Fig. 23: Cut fender liner.

CHECK AND FINAL DETAILS

27. Reinstall the wheels and torque to OEM specifications.

28. Set the vehicle back on the ground and drive back and forth several feet to allow the suspension to settle. Now measure ride height and adjust if necessary. READ INSTALLATION GUIDELINES ON HOW TO PROPERLY ADJUST PRELOAD.

29. Check that the suspension has proper clearance by steering completely in both directions.

30. Measure the vehicle's ride height and adjust if necessary.

31. It is highly recommended your wheel alignment is checked.

REAR SHOCK INSTALLATION

NOTICE: Medium-strength thread-lock is recommended on all bolts.

1. Please read the installation guidelines on page 5 for instructions on how to lift and secure the vehicle.

STOCK SHOCK REMOVAL

2. Remove both rear wheels from the vehicle.
3. Pull out the wheel well liners from the vehicle.
4. Remove the upper and lower shock mount bolts (Fig. 24 & 25).



Fig. 24: Remove upper shock mount bolt.



Fig. 25: Remove lower shock mount bolt.

AFTERMARKET LIFT BLOCK INSTALL

NOTICE: If your vehicle is a TB/AT4 model, skip step 5.

5. If your vehicle is not a TB/AT4 model, an aftermarket lift block kit is required (Fig. 26). Install the lift block kit now, and follow the company's required specifications. After installation, continue to step 6.



Fig. 26: Install the aftermarket lift block kit.

6. The brake line bracket by the bump stop may require a slight bend downward (Fig. 27). The increased lift could potentially stress or damage the brake line if the brake line bracket is not slightly bent.



Fig. 27: Bend the brake line bracket.

FOX SHOCK INSTALL

7. Drill a 1/4" hole in the bed frame support directly above the bump stop (Fig. 28). Drill the hole centered and 3/8" inboard from the edge of the frame support (Fig. 29).

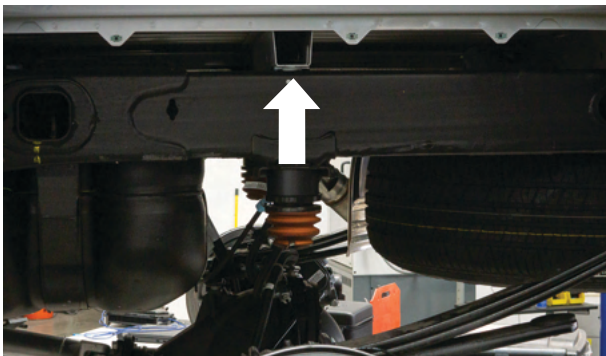

Fig. 28: Drill a hole in the bed frame support.



Fig. 29: Center the hole on the frame support.

8. Before lifting the rear of the bed, apply masking tape to the vehicle's cab to prevent damage if the bed makes contact with the cab.

9. Six bolts attach the vehicle's bed to the frame. Remove the four rear bed bolts (Fig. 30). Loosen the two front bed bolts but do not remove them (Fig. 31).



Fig. 30: Remove rear bed bolts (driver side shown).

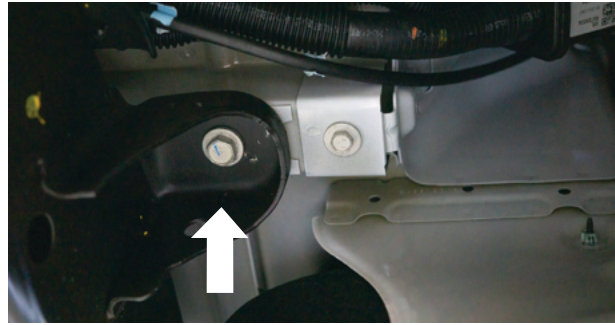

Fig. 31: Loosen front bed bolts (driver side shown).

10. Place jack stands underneath the rear of the bed. Raise the bed off the frame high enough to pass the shock hoses through the gap between the two (Fig. 32).

11. Install the shock with the reservoir bridge facing inboard. The driver side shock hose fittings point toward the front and the passenger side shock hose fittings point toward the rear of the vehicle. Feed the reservoir from the inboard side of the truck to the outside by passing the reservoir between the frame and bed of the truck. (Fig. 33 & 34).

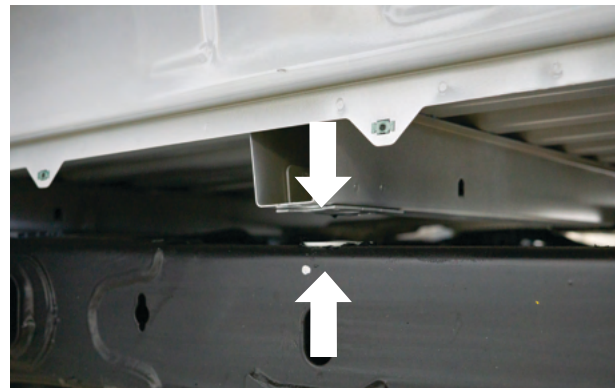

Fig. 32: Lift the bed of the vehicle.

NOTICE: The driver side shock has longer hoses.

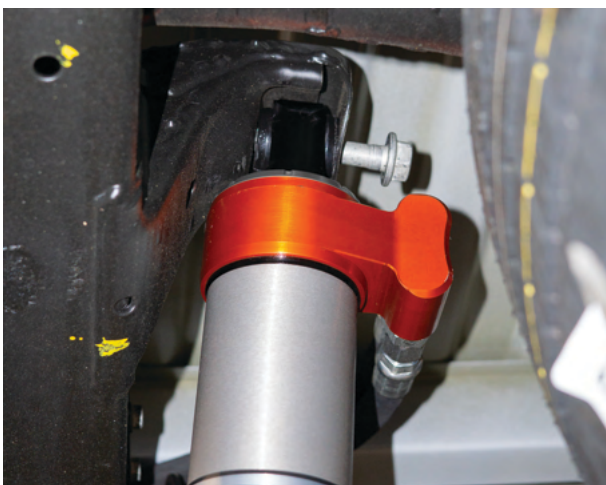

Fig. 33: The reservoir bridge faces inboard.



Fig. 34: Pass reservoir between the frame and bed.

12. Loosely fasten the shock's upper and lower mounts with the OEM bolts (Fig. 35).



Fig. 35: Fasten the shock's lower mount.

13. Move both reservoir hoses through the gap between the vehicle's bed and frame toward the front of the vehicle (Fig. 36).

14. Torque the shocks' mounting hardware to OEM specification.

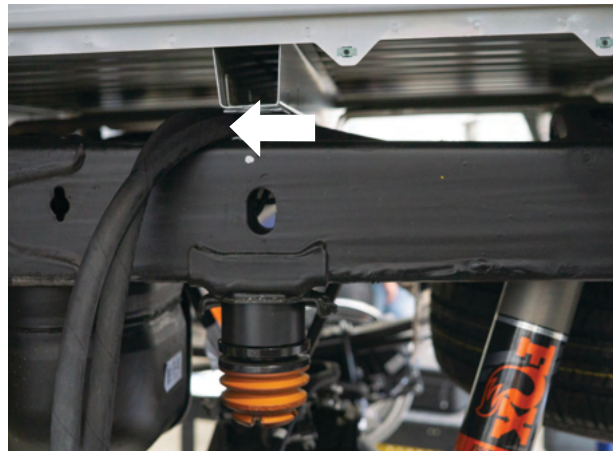

Fig. 36: Route the reservoir.

RESERVOIR INSTALLATION

15. Mount the center of the reservoir bracket (F1) 11" behind the bump stop perch. Drill three 21/64" pilot holes and install the supplied self-tapping screws (G1) (Fig. 37).



Fig. 37: Mount the reservoir bracket.

16. Refer back to page 10 of the Front Shock Installation to mount the reservoir (Fig. 38). The reservoir needs at a minimum 1/8" clearance from any surrounding vehicle parts (Fig. 39).



Fig. 38: Mount the reservoir.



Fig. 39: Check the clearance.

17. Install the supplied P-Clamp (H1) on the upper hose (Fig. 40). Make sure the hoses are not contacting parts of the vehicle that may cause abrasions.

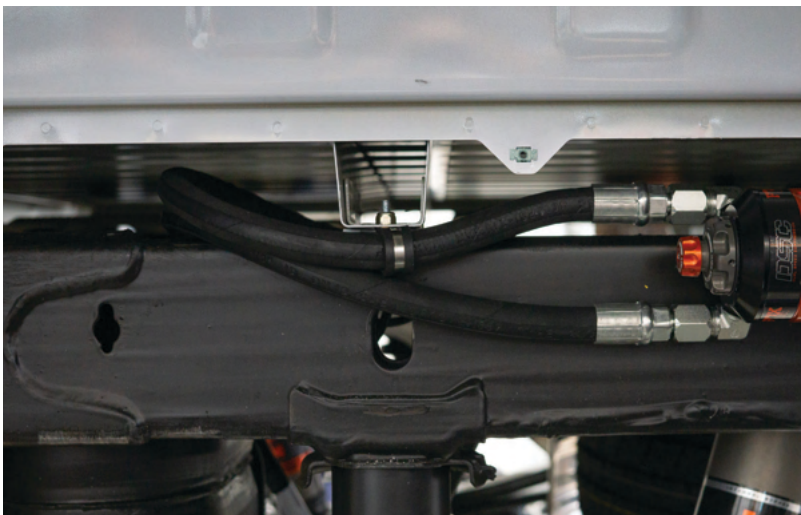

Fig. 40: Install the P-Clamp.

18. Slowly lower the vehicle's bed back to the frame. Check that the shock's hoses are appropriately routed and clear the surrounding vehicle parts. Torque the six bed bolts to OEM specification.

WHEEL WELL LINER TRIMMING

19. Test fit the wheel well liner and assess how much trimming is required. Draw a cut line on the liner.

20. Remove the wheel well liner and begin with a conservative cut. Repeat test fitting and cutting until the desired appearance is achieved (Fig. 40).



Fig. 40: Cut the wheel well liner.

CHECK AND FINAL DETAILS

21. Reinstall the wheels and torque to OEM specifications.

22. It is highly recommended your wheel alignment is checked.

FOX FACTORY DSC

DUAL SPEED COMPRESSION (DSC) ADJUSTER SETTINGS

DSC HIGH SPEED COMPRESSION

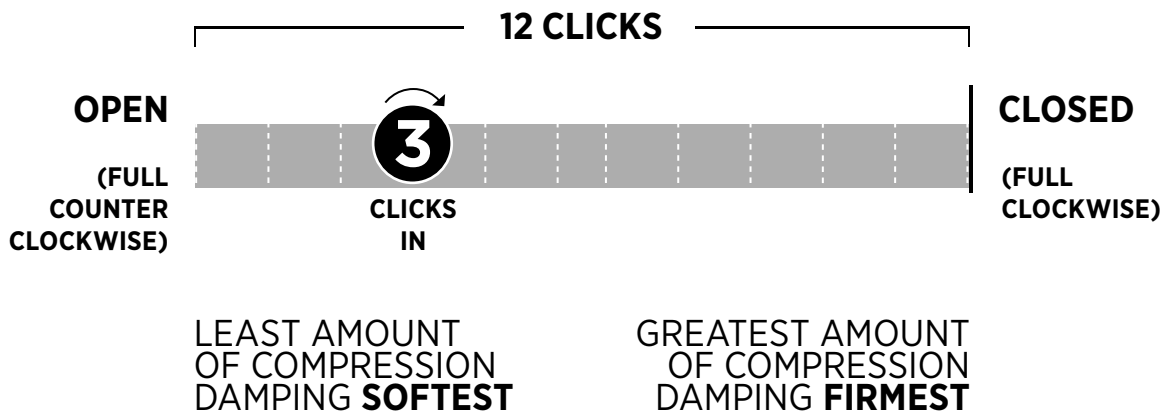

DSC LOW SPEED COMPRESSION

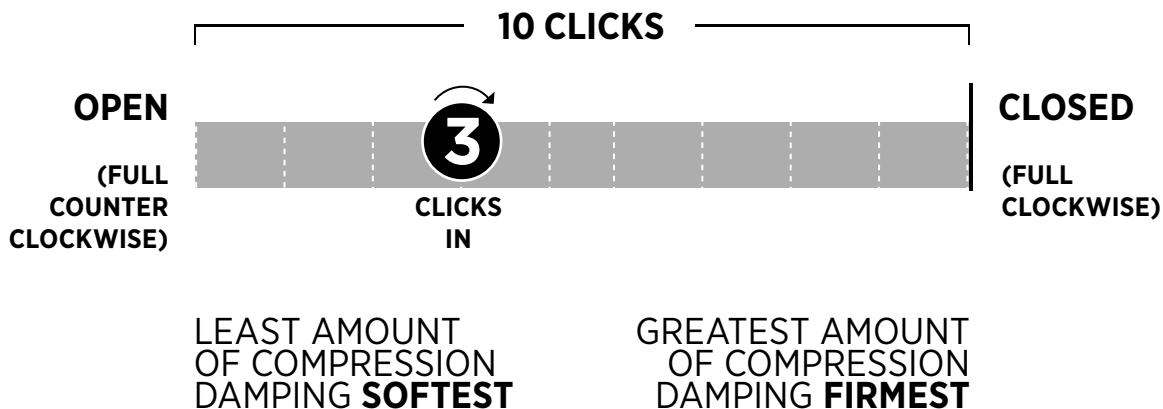

WARRANTY INFORMATION

FOX LIMITED WARRANTY

FOX Factory, Inc., a Georgia corporation having an office at 2055 Sugarloaf Cir. Duluth, GA 30097 (“FOX”), makes the following LIMITED WARRANTY with respect to its suspension products:
LIMITED ONE (1) YEAR WARRANTY ON SUSPENSION PRODUCTS.

Subject to the limitations, terms and conditions hereof, FOX warrants, to the original retail owner of each new FOX suspension product, that the FOX suspension product, when new, is free from defects in materials and workmanship. Unless otherwise required by law, this warranty expires one (1) year from the date of the original FOX suspension product retail purchase from an authorized FOX dealer or from a FOX authorized Original Equipment Manufacturer where FOX suspension is included as original equipment on a purchased vehicle. If law requires a warranty duration of greater than one (1) year, then, subject to the other provisions hereof, this warranty will expire at the end of the minimum warranty period required by such law.

TERMS OF WARRANTY

This warranty is conditioned on the FOX suspension product being operated under normal conditions and properly maintained as specified by FOX. This warranty is only applicable to FOX suspensions purchased new from an authorized FOX source and is made only to the original retail owner of the new FOX suspension product and is not transferable to subsequent owners. This warranty is void if the FOX suspension product is subjected to abuse, neglect, improper or unauthorized repair, improper or unauthorized service or maintenance, alteration, modification, accident or other abnormal, excessive, or improper use.

Should it be determined by FOX in its sole and final discretion, that a FOX suspension product is covered by this warranty, it will be repaired or replaced, by a comparable model, at FOX’s sole option, which will be conclusive and binding. THIS IS THE EXCLUSIVE REMEDY UNDER THIS WARRANTY. ANY AND ALL OTHER REMEDIES AND DAMAGES THAT MAY OTHERWISE BE APPLICABLE ARE EXCLUDED, INCLUDING, BUT NOT LIMITED TO, INCIDENTAL OR CONSEQUENTIAL DAMAGES OR PUNITIVE DAMAGES.

This limited warranty does not apply to normal wear and tear, malfunctions or failures that result from abuse, improper assembly, neglect, alteration, improper maintenance, crash, misuse or collision. This limited warranty gives the consumer specific legal rights. The consumer may also have other legal rights which vary from state to state or country to country. Some states and countries do not allow the exclusion or limitation of incidental or consequential damages or warranties, and if dictated by law the above limitations or exclusions may not apply to you. If it is determined by a court of competent jurisdiction that a certain provision of this limited warranty does not apply, such determination shall not affect any other provision of this limited warranty and all other provisions shall remain in full effect.

THIS IS THE ONLY WARRANTY MADE BY FOX ON ITS SUSPENSION PRODUCTS AND COMPONENTS, AND THERE ARE NO WARRANTIES WHICH EXTEND BEYOND THE DESCRIPTION HEREIN. ANY WARRANTIES THAT MAY OTHERWISE BE IMPLIED BY LAW INCLUDING, BUT NOT LIMITED TO, ANY IMPLIED WARRANTY OF MERCHANTABILITY OR FITNESS FOR A PARTICULAR PURPOSE ARE EXCLUDED.

SHOCKS NEED LOVE TOO

FOX SERVICE AND UPGRADES

HAVE YOUR FOX SHOCKS SERVICED BY FOX TECHNICIANS. CALL OUR OFF-ROAD AND TRUCK SERVICE CENTER AT 619.768.1800 TO GO OVER THE SERVICE AND UPGRADE OPTIONS AVAILABLE FOR YOUR PRODUCT. ONCE YOU'VE SETUP YOUR SERVICE AND/OR UPGRADES YOU WILL RECEIVE A RETURN AUTHORIZATION NUMBER AND SHIPPING INSTRUCTIONS.

COMPLETE SERVICES

100% street use: every 50,000 miles

50% street/ 50% off-road use: Every 10,000 miles

SERVICE MENUS AND PRICING

visit ridefox.com/service



**WARNING: Cancer and
Reproductive Harm –**
www.P65Warnings.ca.gov

