

# ROUGH COUNTRY

## SUSPENSION SYSTEMS®

### JEEP 07-16 JK INNER FENDERS

Thank you for choosing Rough Country for your suspension needs.

Rough Country recommends a certified technician install this kit. In addition to these instructions, professional knowledge of disassemble/reassembly procedures as well as post installation checks must be known. Attempts to install this kit without this knowledge and expertise may jeopardize the integrity and/or operating safety of the vehicle.

Please read instructions before beginning installation. Check the kit hardware against the parts list. Be sure you have all needed parts and know where they go. Also please review tools needed list and make sure you have needed tools.

#### PRODUCT USE INFORMATION

**▲WARNING** As a general rule, the taller a vehicle is, the easier it will roll. Seat belts and shoulder harnesses should be worn at all times. Avoid situations where a side rollover may occur. Generally, braking performance and capability are decreased when larger/heavier tires and wheels are used. Take this into consideration while driving. Do not add, alter, or fabricate any factory or after-market parts to increase vehicle height over the intended height of the Rough Country product purchased. Mixing component brands is not recommended.

Rough Country makes no claims regarding lifting devices and excludes any and all implied claims. We will not be responsible for any product that is altered. If question exist we will be happy to answer any questions concerning the design, function, and correct use of our products by calling 1-800-222-7023.

**▲NOTICE** These inner fenders are designed using the OE hole locations, and with Rough Country's Flat Fender set. If you have any other aftermarket, or OE fenders, some modifications may be necessary to complete the install.

#### **▲NOTICE** NOTICE TO DEALER AND VEHICLE OWNER

Any vehicle equipped with any Rough Country product should have a "Warning to Driver" decal installed on the inside of the windshield or on the vehicle's dash. The decal should act as a constant reminder for whoever is operating the vehicle of its unique handling characteristics.

INSTALLING DEALER - it is your responsibility to install the warning decal and forward these installation instructions on to the vehicle owner for review. These instructions should be kept in the vehicle for its service life.

#### **Kit Contents:**

Dr & Pass Frt Inner Fender  
 Dr & Pass Middle Inner Fender  
 Dr & Pass Rr Bracket  
 1195BAG  
 Instructions

#### 1195Bag:

(34) 6mm x 20mm Bolts  
 (6) 8mm x 25mm Bolts  
 (34) 6mm Flat Washers  
 (6) 8mm Flat Washers  
 (12) 6mm Nylock Nut  
 (16) 6mm Clip Nut  
 (6) 8mm Clip Nut

#### **Wrenches And Tools Needed:**

4mm Allen  
 6mm Allen  
 10mm Wrench  
 5/16" Drill  
 Drill Motor  
 Wheel Chocks

1. Make sure vehicle is off and in park before beginning. Lift vehicle for easy access or may be completed on the ground using wheel chokes to prevent movement.
2. Place the backing plate behind the RC logo. **Photo 1.**
3. Attach using (6) of the 6mm x 20 bolts, washers, and nuts. Tighten using a 4mm Allen and 10mm wrench. **Photo 2.**



**PHOTO 1**

**Place backing plate behind RC.**



**PHOTO 2**

**Attach backing plate using 6mm hardware.**

4. Place the clip nuts in the proper locations. 8mm will use the larger holes, 6mm the smaller. **Photo 3.**
5. Place the Fr inner fender (RC Logo) on top of the middle inner fender. **Photo 4.**

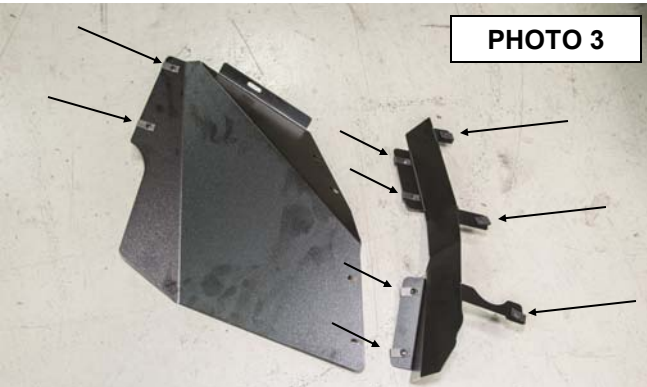

**PHOTO 3**

**Install the clip nuts.**

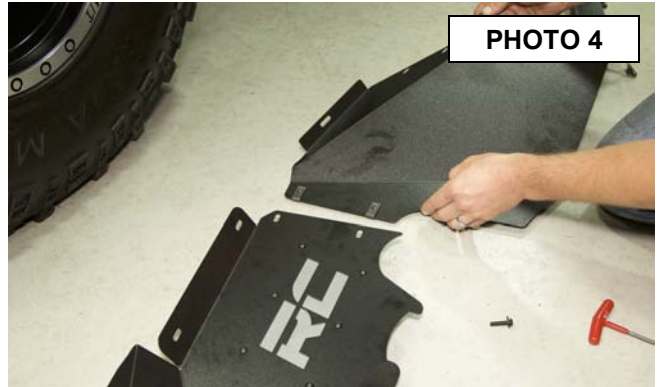

**PHOTO 4**

**Attach the frt and middle liners.**

6. Attach using the 6mm x 20mm bolts and washers. **Do Not Tighten.** **Photo 5.**
7. Install the rear inner fender bracket into the rear of the front fender opening using the 8mm x 25mm bolts and washers. **Photo 6.**

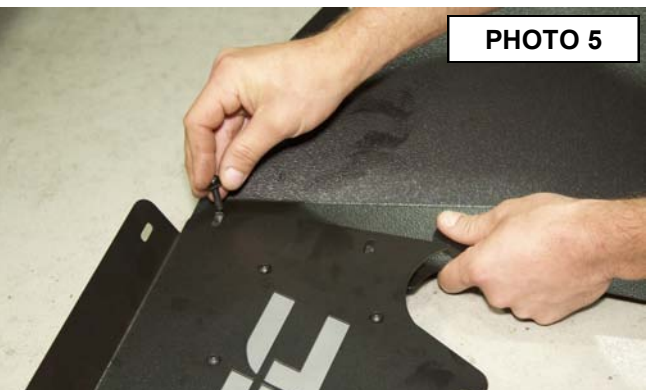

**PHOTO 5**

**Secure using the 6mm hardware.**



**PHOTO 6**

**Install the rear bracket into the fender opening.**

8. Install the front and middle assembly into the wheel well. **Photo 7.**
9. Use (4) 6mm x 20mm bolts and washers to attach the inner fender to the body. **Photo 8.**

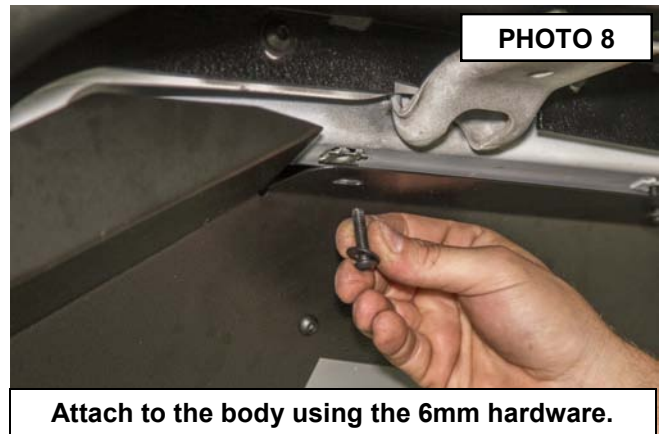

10. Connect the middle inner with the rear bracket, using (4) 6mm x 20mm bolts and washers. **Photo 9.**
11. Position the inner fenders and tighten all hardware using a 4mm and 6mm Allen.
12. Using a 5/16" drill and the inner fender as a guide, drill a hole in the body mount. **Photo 10**



13. Install a 6mm clip nut on the body mount. **Photo 11.**
14. Attach the inner fender using a 6mm x 20mm bolt and washer, tighten using a 4mm Allen.
15. Repeat steps 2-14 on opposite side.
16. This completes the install. Thanks for buying Rough Country.

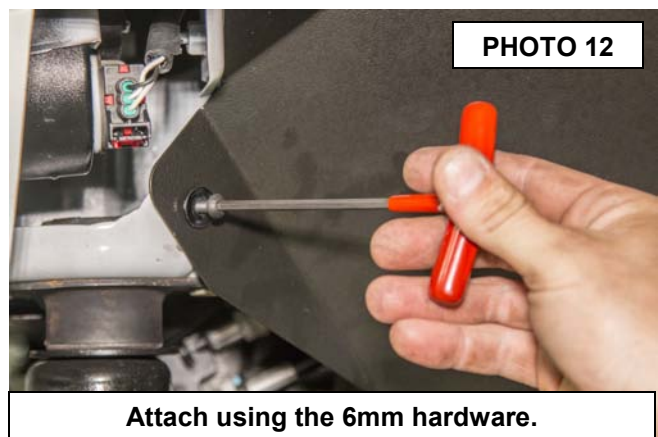
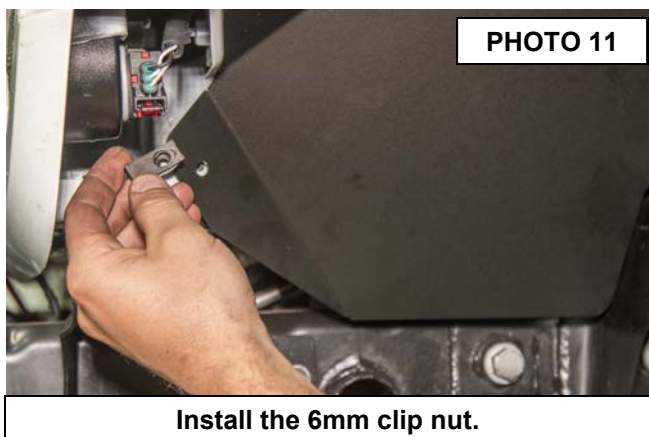





1195V Vertex Shock Version

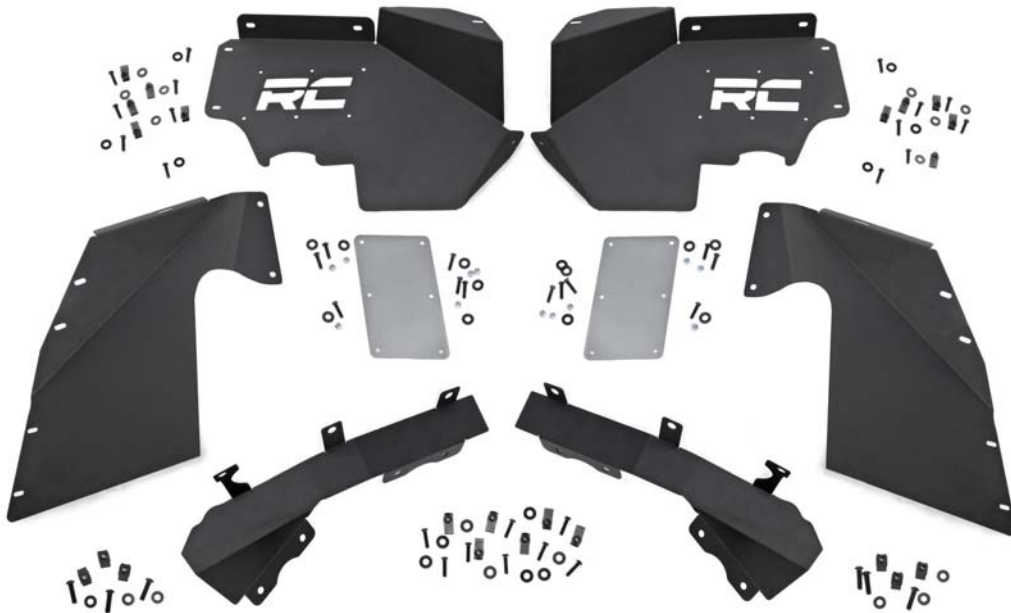

By purchasing any item sold by Rough Country, LLC, the buyer expressly warrants that he/she is in compliance with all applicable , State, and Local laws and regulations regarding the purchase, ownership, and use of the item. It shall be the buyers responsibility to comply with all Federal, State and Local laws governing the sales of any items listed, illustrated or sold. The buyer expressly agrees to indemnify and hold harmless Rough Country, LLC for all claims resulting directly or indirectly from the purchase, ownership, or use of the items.

