

ROUGH COUNTRY

SUSPENSION SYSTEMS®

JEEP JL / GLADIATOR / JK WINCH BUMPER

Thank you for choosing Rough Country for all your suspension needs.

Please read instructions before beginning installation. Check the kit hardware against the parts list. Be sure you have all needed parts and know where they go. Also please review tools needed list and make sure you have needed tools.

PRODUCT USE INFORMATION

Please read instructions before beginning installation. Check the kit hardware against the parts list and product layout. Be sure you have all needed parts and know where they go. Also please review tools needed list and make sure you have needed tools.

If questions exist we will be happy to answer any questions concerning the function and correct use of this product.

The installer must verify that the mounting kit does not interfere with the factory air bag sensors, which must not be relocated or modified in any way. The vehicles air bag system may not operate properly if the winch mounting kit is not mounted in compliance with the vehicle manufacturers recommendations.

Kit Contents:

10585-Fr Winch Bumper

- 2-D-rings
- 1-20" Slim Line LED Light
- 2-2" LED Lights
- 2 - Mounting Plates

10585bag:

- 2-D-rings
- 4-12mm Flag Nuts
- 14-4mm 15mm button head bolt
- 14-4mm hex nut
- 28-4mm Flat Washer
- 14-4mm Lock washer
- 8-6mm x20mm button head bolt
- 2-6mm Flange Nut
- 2-6mm Flat Washer
- 2-6mm Hex Nut
- 8-8mm Lock Washer
- 18-8mm Flat Washer
- 2-8mm x16mm Hex Bolt
- 6-8mm Hex Nut
- 10-8mmx 30mm Button head bolt
- 4-8mm Flange Nut
- 8-12mm Flat Washer
- 8-12mm Lock Washer
- 4-12mm Hex Nut
- 4-12mm x 35mm Hex bolt
- 2-8mm Flag nuts
- 4-Plastic bolt retainers

Tools Needed:

- 13mm Wrench/Socket
- 18mm Wrench/Socket
- 16mm Wrench/Socket
- 2mm Allen Wrench
- 4mm Allen Wrench
- 5mm Allen Wrench
- 6mm Allen Wrench
- Flat Head Screwdriver
- 7mm Wrench/Socket



INSTALLATION INSTRUCTIONS

1. Place vehicle on a flat surface and set emergency brake.
2. Remove the 2 plastic pins on the top of the front bumper cover between the bumper and grill and the clips holding the trim piece to the bumper. **See Photo 1.**
3. Remove the two 6mm screws from the factory lower skid plate. **See Photo 2.**

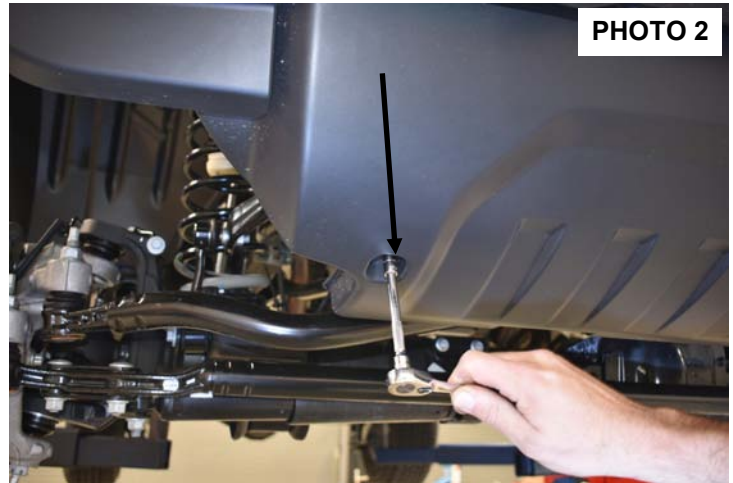

4. Unplug the fog light wiring harness on the passenger side as shown in **Photo 3.**
5. Remove the 4 bolts on each side using a 18mm socket and remove the bumper from the vehicle. **See Photo 4 & 5.**

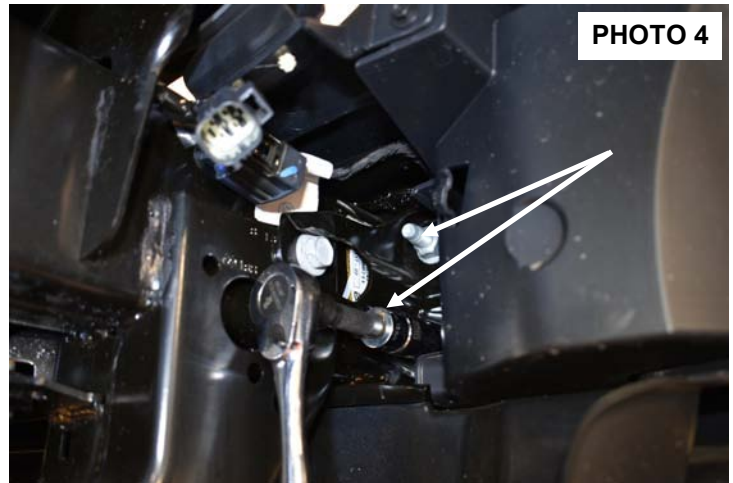
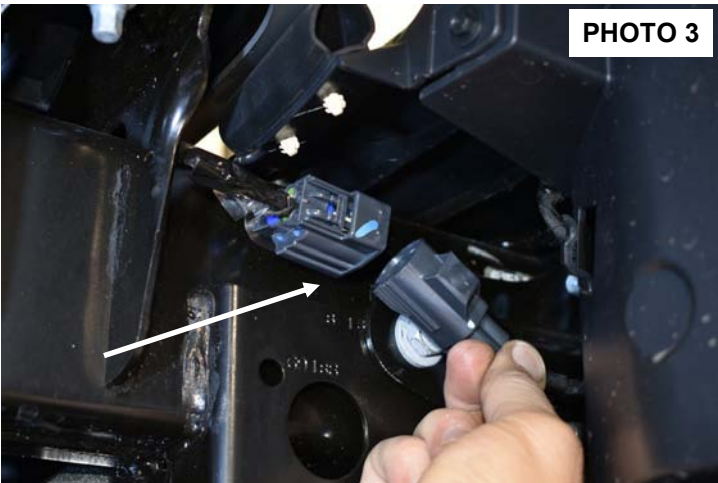

6. Remove the factory crash bar as shown in **Photo 6** using a 16mm socket.

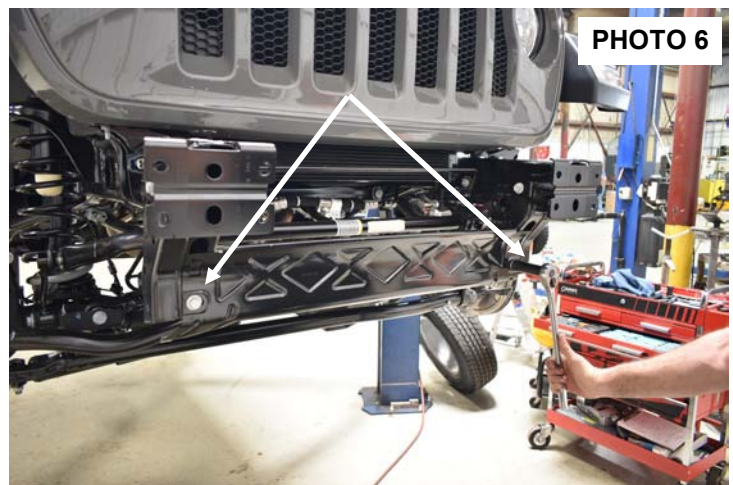
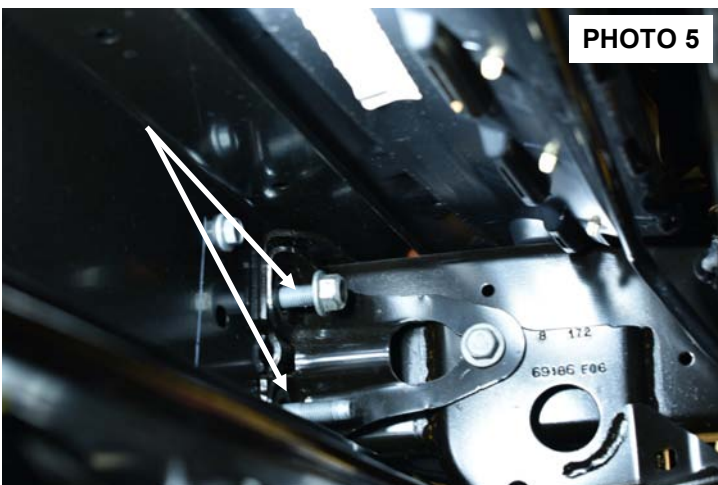

7. The next steps will be followed if utilizing the stock fog lights. Both the halogen and LED fog lights are accommodated in this kit by using the appropriate mounting plate. If using Rough Country flush mount lights please skip to step 17.
8. To use the factory fog lights the factory harness will be reused and the stock bumper will be dis-assembled to remove the light harness.
9. Using a pry tool, remove the 8 plastic rivets securing the lower cover to bumper as shown. **See Photo 7.**
10. Using a pry tool, remove the 6 plastic rivets as shown on the outer light covers and remove from bumper. **See Photo 8.**



11. Using a pry tool, remove the 6 plastic rivets securing the trim to bumper. **See Photo 9.**
12. Unplug the light from the harness and remove the light mount from the bumper using a 13mm socket. **See Photo 10.**

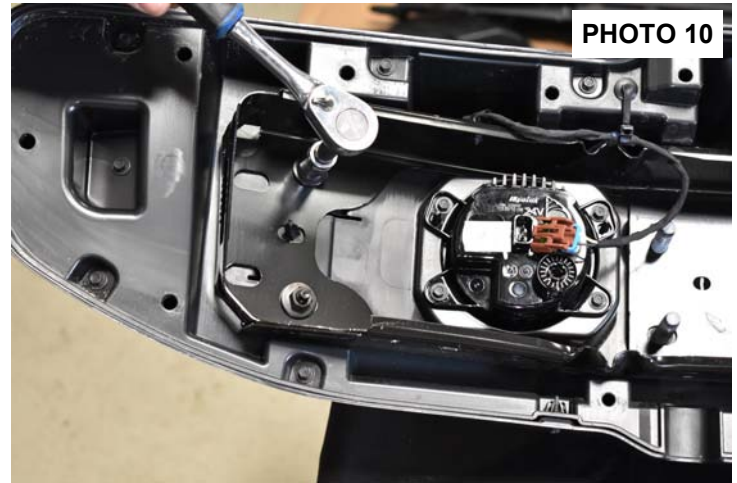
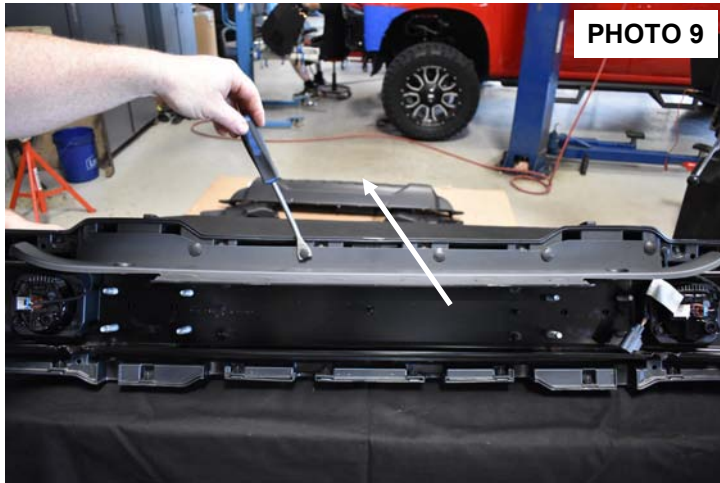

13. Using a pry tool, remove the harness from the inner steel assembly and remove the steel assembly from the outer shell.
14. Remove the stock lights from the bumper using a 7mm socket.
15. Remove the inner shell from the outer shell removing the 24 stock bolts using a 7mm socket. **See Photo 11.**
16. Remove the stock fog light harness from the stock bumper using a pry tool. **See Photo 12.**



17. Install the hawse or roller fairlead and winch on the bumper using the hardware from the winch kit.
18. Choose appropriate mounting plate depending on which light is used for the bumper. **See Photo 13.**
19. Install the fog light plate in the bumper using the supplied 6mm button head bolts. Tighten using a 4mm allen wrench. **See Photo 14.** If using stock fog lights, install stock wiring harness removed from stock bumper at this time. Route wiring harness out of harms way and secure to bumper using cable ties if needed.

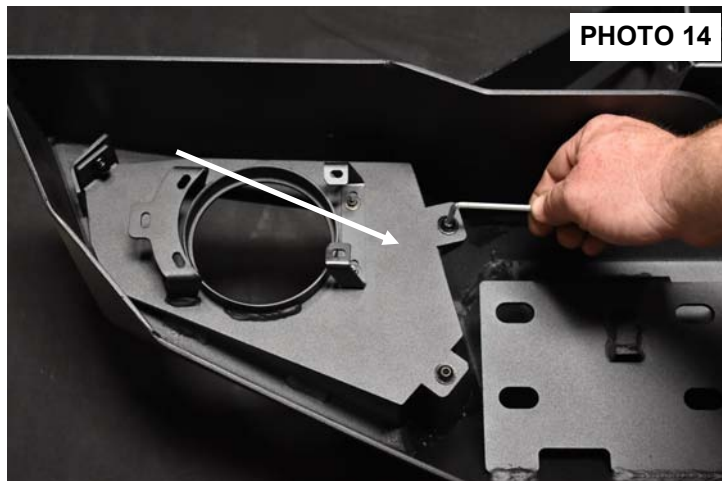
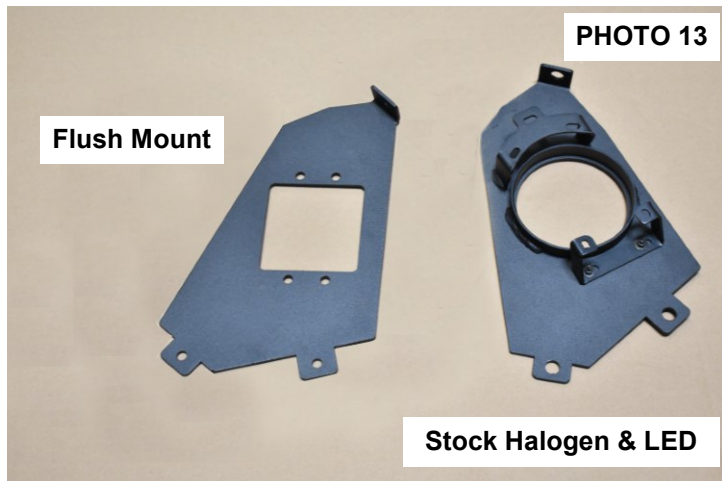

20. Install the lights in the mounting plate using the 4mm bolts and tighten using a 2mm allen wrench. (LED lights shown). **See Photo 15.**
21. Install the LED light bar in the light mount and if used, flush mount LED lights in the bumper. Hardware with those kits will be used to install those lights.
22. Install the supplied flag nuts plates and secure them to the bumper using the plastic retainers. 2 per side. **See Photo 16.**

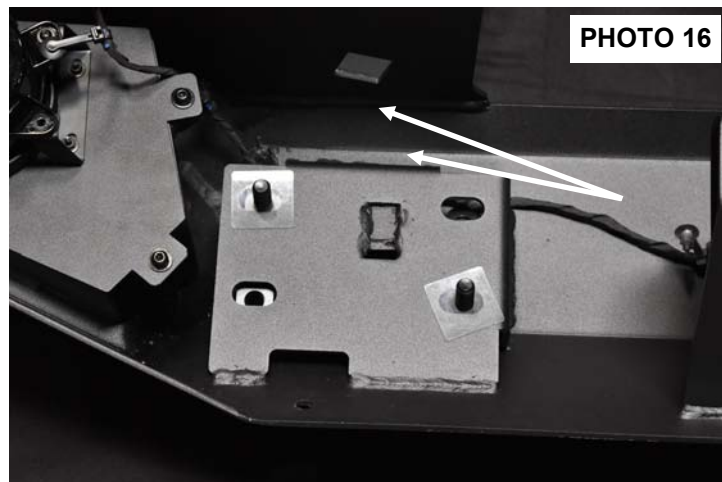
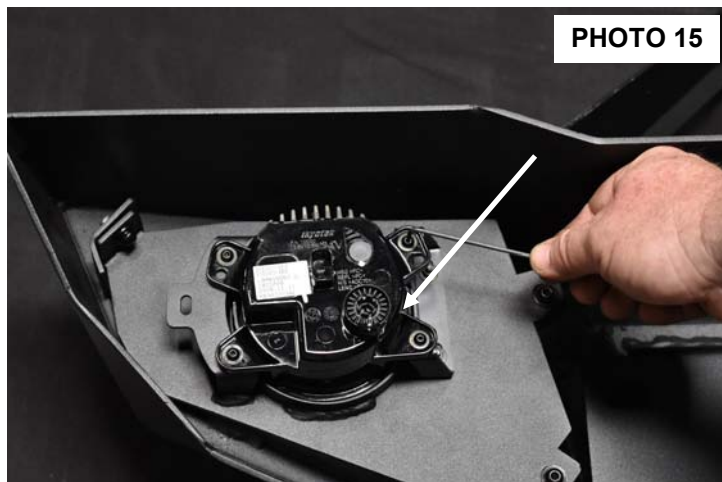

23. Install the bumper in the factory mounting locations and secure with the supplied 12mm washers and nuts using a 18mm socket. Also install the supplied 12mm bolts in the bumper. Do not tighten at this time to allow bumper to be adjusted. **See Photo 17.**
24. Install the lower skid plate brackets to the frame as shown for JL/JT models in **Photo 18** and JK models in **Photo 19** with the supplied 8mm button head bolts, washers and nuts. Tighten hardware using a 6mm allen wrench and 13mm wrench.

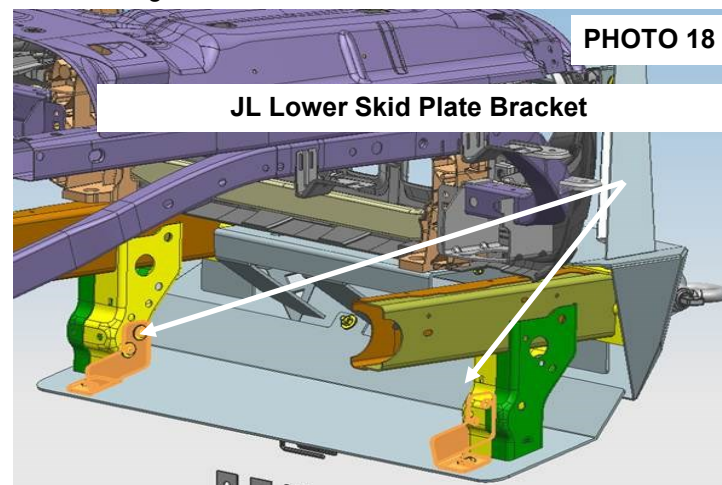
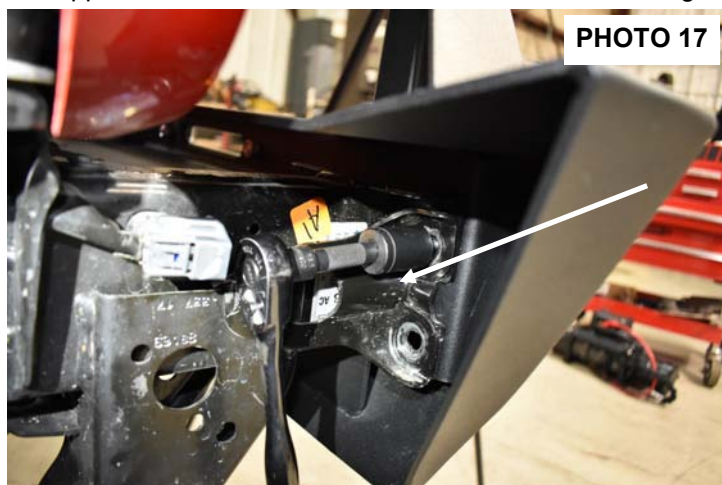

25. Install the skid plate to the brackets with the supplied 8mm button head bolts, washers and nuts. **See Photo 20.**
26. Secure the skid plate to the bumper with the supplied 8mm button head bolts, washers and nuts. **See Photo 21.**
27. If using factory fog lights, plug lights into stock harness. If using Rough Country lights, wire lights using those instructions.
28. Center bumper on vehicle and tighten hardware using a 18mm wrench.

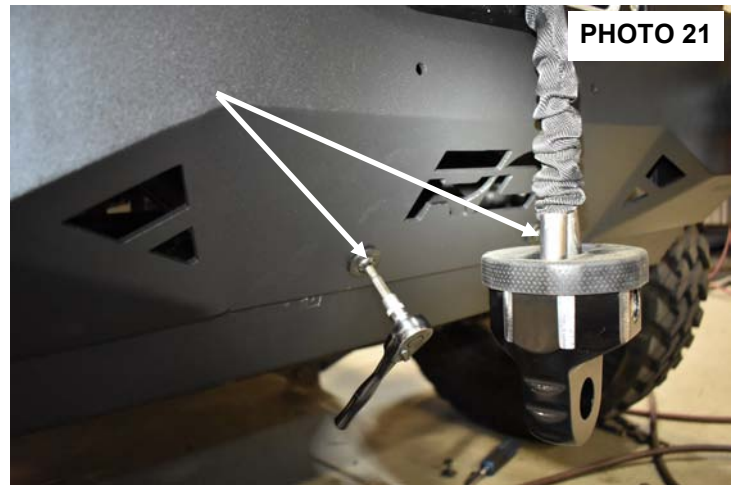
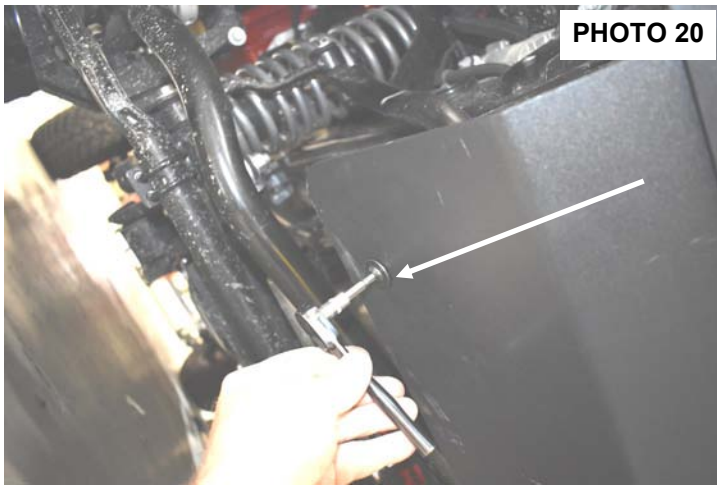
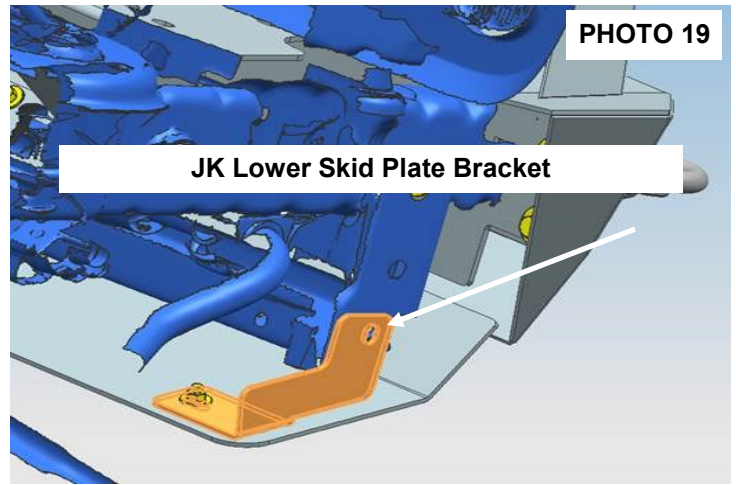

MAINTENANCE INFORMATION

1. Failure to securely tighten all bolts on the winch bumper, winch, and fairlead can result in product failure, which may result in vehicle damage or operator injury. Check that all bolts are securely tightened prior to use.
2. Inspect all nuts and bolts on the winch, bumper, and related hardware prior to each use. Tighten all nuts that appear to be loose. Stripped, fractured, or bent bolts or nuts should be replaced.
3. Periodically check bolt for tightness.

OPTIONAL ACCESSORIES FOR JK WINCH BUMPER CALL YOUR ROUGH COUNTRY DEALER TO ORDER



**ROUGH COUNTRY ELECTRIC WINCH
AVAILABLE IN 9500LB & 12000LB**

SYNTHETIC WINCH ROPES



WINCH COVER



PART # RS120 WINCH STRAP



THANK YOU FOR CHOOSING ROUGH COUNTRY FOR YOUR OFF ROAD NEEDS



By purchasing any item sold by Rough Country, LLC, the buyer expressly warrants that he/she is in compliance with all applicable, State, and Local laws and regulations regarding the purchase, ownership, and use of the item. It shall be the buyer's responsibility to comply with all Federal, State and Local laws governing the sales of any items listed, illustrated or sold. The buyer expressly agrees to indemnify and hold harmless Rough Country, LLC for all claims resulting directly or indirectly from the purchase, ownership, or use of the items.