



34935 Flyover Ct. Bakersfield, CA 93308  
Phone: (661) 588-8085 | Fax: (661) 588-8295

**INSTALL INSTRUCTIONS:**

Cognito SM Series Uniball  
Upper Control Arm Kit for  
**2020 GM 2500HD/3500HD**  
**2WD/4WD Trucks**  
**SKU: 110-90805**



**PARTS LIST FOR SKU: 110-90805**

QUANTITY	PART #	DESCRIPTION
1	8689	Driver Uni Ball Upper Control Arm 2020 GM 8-Lug
1	8690	Passenger Uni Ball Upper Control Arm 2020 GM 8-Lug
1	<b>HP9158</b>	Bushing Kit for Cognito Upper Control Arms on 2011-2019 GM 2500HD / 3500HD 2WD/4WD trucks
2	6446	1-1/4" BILLET UNI BALL CAP
2	<b>HP9273</b>	2020 GM 2500 UNIBALL PIN KIT (COM20)
2	UNI-BALL- COMH20T	Uni Ball COMH20T 1.25" With F-2 Fit Teflon Liner. (pre-installed)
2	HARDWARE- SPIROLOX- 2.375	2.375" Spirolox Internal Retaining Ring (pre-installed)

**WARNING**

Please read this entire instruction sheet before beginning installation. Proper installation of these components requires a qualified mechanic. Always wear safety glasses when using power tools, and take appropriate precautions when working under a vehicle. If these instructions are not properly followed you may jeopardize your, and your passenger's safety, and severe frame, suspension or tire damage may also result from improper installation.

**PARTS LIST FOR SKU: HP9273**

QUANTITY	PART #	DESCRIPTION
1	6445	Uniball Hat, 2019 GMC 1500
1	6445	Uniball Pin, 2011 - Present GM 2500
1	HARDWARE- 0150959	2 g Pouch Copper C5-A® General Purpose Anti-Seize Lubricant
1	HARDWARE- 0161379	1/2-20 X1" 12 Point Plain Finish Flange Screw
1	HARDWARE- 33626	33626 1/2" L/W Z
1	HARDWARE- CASTLENUT-M14- 1.5	M14-1.5 Castle Nut 15Mm Tall
1	HARDWARE- COTTERPIN-1	Cotter Pin For Ball Joints
1	HARDWARE-M14- F/W	Zinc-Plated Steel Washer For M14 Screw Size 15 Mm Id 28 Mm Od

**PARTS LIST FOR SKU: HP9158**

QUANTITY	PART #	DESCRIPTION
4	5490	Crush Sleeve 1" X .180" X 2.54"
8	POLY-BUSHING- 2862.01	Black Polyurethane Spring Bushing
4	Black Polyurethane Spring Bushing	1/4-28 45Deg Angle Zerk Grease Fitting

## REQUIREMENTS

- Always wear safety glasses when using power tools. Some cutting is required.
- With taller than stock wheels and tires, trimming will still be required to the back bottom of the fender well area and the plastic valance under the front bumper.
- A minimum amount of droop travel is required for proper ride quality and component life.
- Proper shocks and shock lengths must be used, or damage to control arms, ball joints, and vehicle will occur.

## TECH NOTES

- Installation requires a qualified mechanic.
- Read instructions carefully and study the pictures before attempting installation.
- Check the parts and hardware packages against the parts list to assure that your kit is complete.
- Cutting of the service perch under the front upper arm frame pivot is required.

## TOOLS YOU WILL NEED

- Measuring tape
- Jack and stands or vehicle lift
- Hammer
- 18mm socket or wrench
- 22mm socket or wrench
- 10mm socket or wrench
- 13mm socket or wrench
- 24mm socket and wrench
- Torque wrench ft-lb
- Grease gun
- Reciprocating saw/angle grinder

## INSTALLATION

1. Rack the vehicle and hoist it off the ground by the frame so that the front suspension is at the full droop position. If no hoist is available, then jack the front of the truck off the ground and support the frame properly with jack stands. NEVER WORK ON AN UNSUPPORTED VEHICLE.
2. Check the shock length. Using a shock that is too long will cause the upper ball joint to bind and break. Therefore, the correct length shock must be used. For this kit, the maximum shock length that can be used is 19.0" from the center of the lower eyelet to the mounting face at the top of the shock as shown in figure 1 below. If any shock spacers are used with this UCA kit, they must be added to the measurement from figure 1 and that number must be under 19.4". If this control arm kit is used with any other parts then specified, warranty will be void on this arm kit, and damage may occur to arms, ball joints, tie rods, cv axles and possibly death. This measurement may be taken while the shock is installed on the vehicle and it is lifted by the frame with the wheels off the ground at the full droop position. Do not remove or unbolt the shock while the torsion bars are loaded.

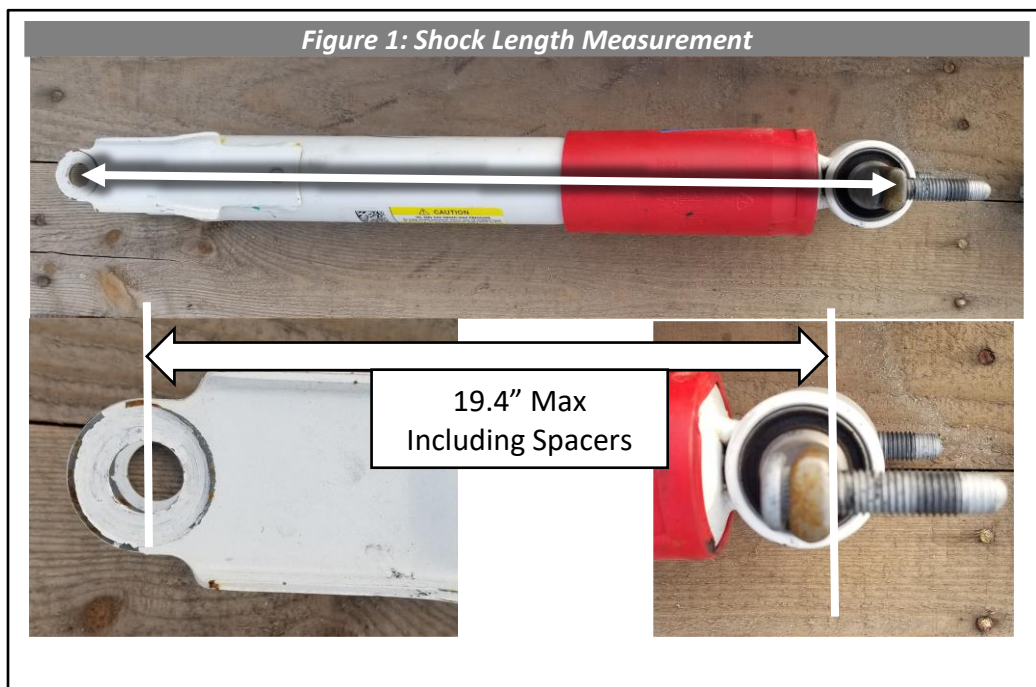

3. Remove the factory upper control arms. With an 18mm socket, loosen the ball joint nut of the upper control arm enough until you can spin the nut with your fingers, but do not remove totally. While prying the control arm away from the spindle, hit the side of the spindle with a hammer to dislodge the taper seat. When the tapered seat of the ball joint breaks loose, you may then remove the ball joint nut, and separate the factory upper control arms from the spindles. See figure 2.

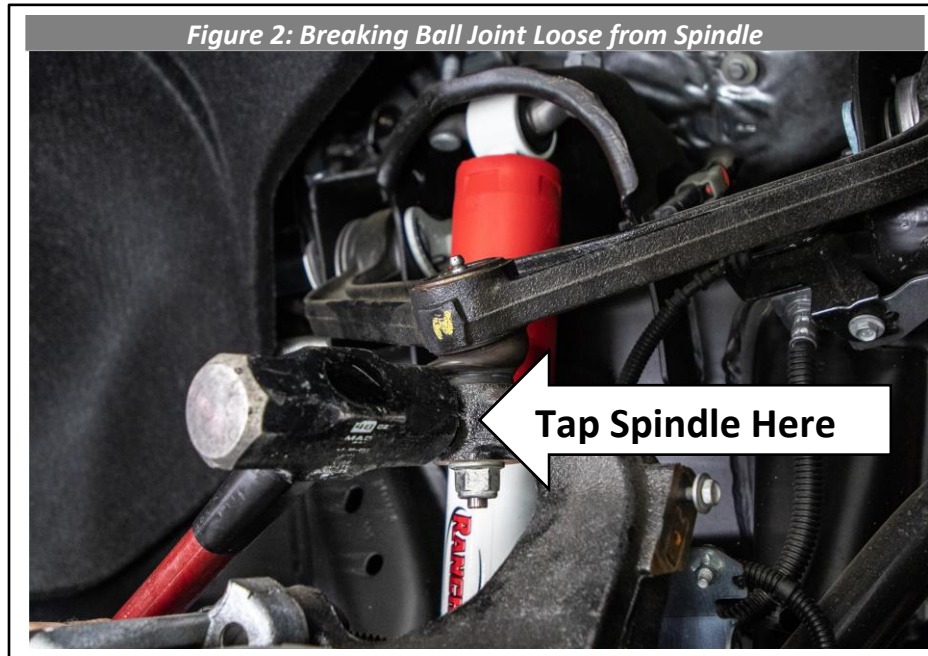

4. Remove the factory bolts and eccentric washers that connect the control arm to the frame with a 24mm wrench, but retain them for future use. Place them aside in order so they can be re-installed in the same place they came off. If still equipped, leave the OEM plastic alignment inserts in the eccentric washers to aide in camber and caster alignment.
5. Locate hardware pack **HP9273** and install the uniball pin, uniball hat, lock washer, and 12 point screw in the order shown in figure 3. You will need to wait until the pin is mounted to the spindle in order to torque the 12 point screw and install the uniball cap **HP9264**. Use the provided Anti-Seize and torque to 65 ft-lb.

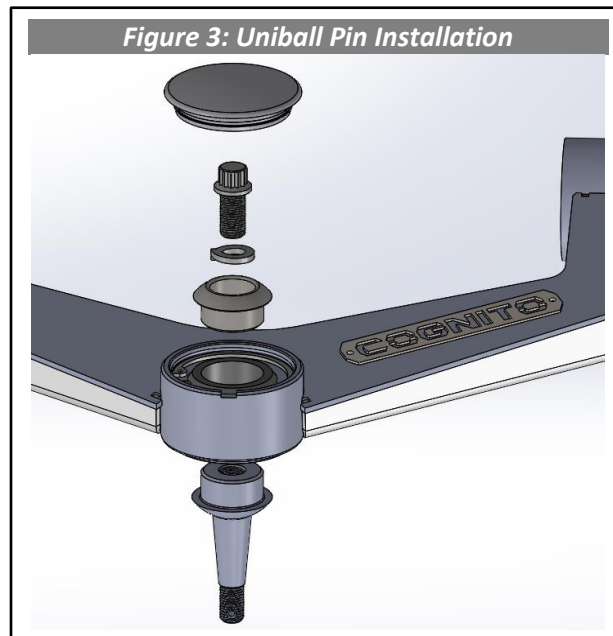

- From the hardware package **HP9158**, insert the polyurethane bushings, crush sleeves, and grease fittings into the ends of the upper control arms. Cognito recommends using black weather-stripping adhesive to ensure secure installation of bushings and use grease to aid installation of sleeves. Do not over tighten the grease fittings, tighten until they are snug and pointing outward toward the tire (See figure 4).

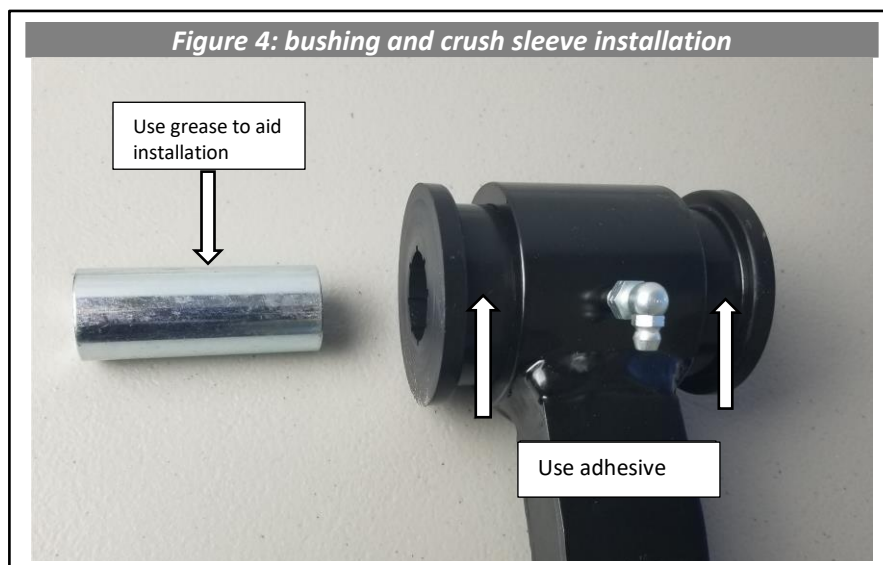

- Remove the wheel speed sensor and brake line bracket that are attached to the spindle (see figure 5). There are 3 screws that require a 10mm wrench. This will give space for cutting the service perch.



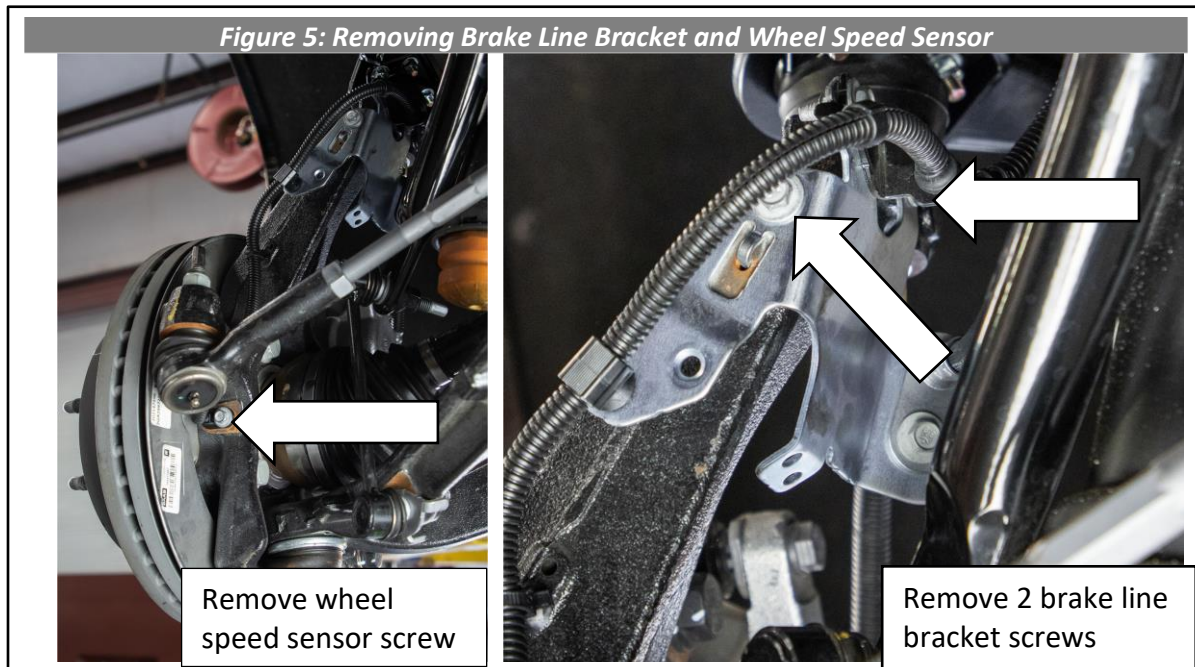

8. Due to the added droop travel when using the Cognito upper control arms, the service perch under the upper control arm which is welded to the frame, must be partially cut off. Start by removing the 13mm screw for the brake line bracket attached to the service perch (see figure 6).

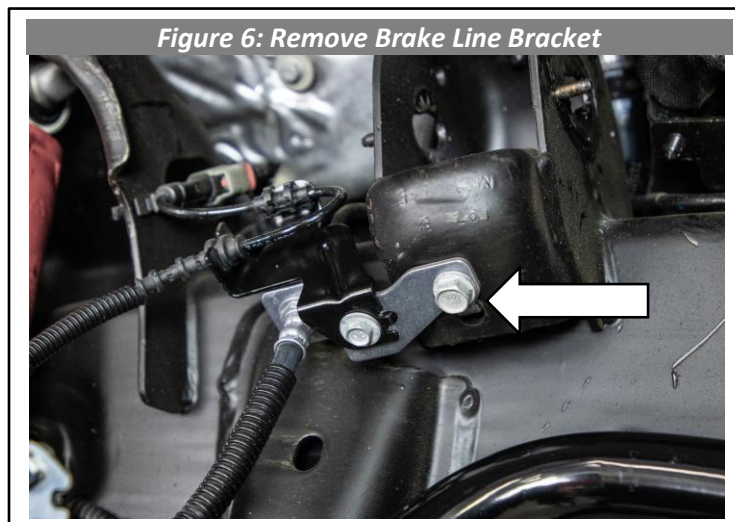

9. Mark the service perch in the 3 locations shown in figure 7 with the lower horizontal line 1/2 inch above the brake line bracket mounting hole. Tie the lines and wires up so they are clear of the cutting area. Take great care to keep the lines and wires safe during the cut and make sure to shield them from sparks if any kind of grinder is used. Wear safety glasses.

*Figure 7: Mark and Cut the Service Perch*

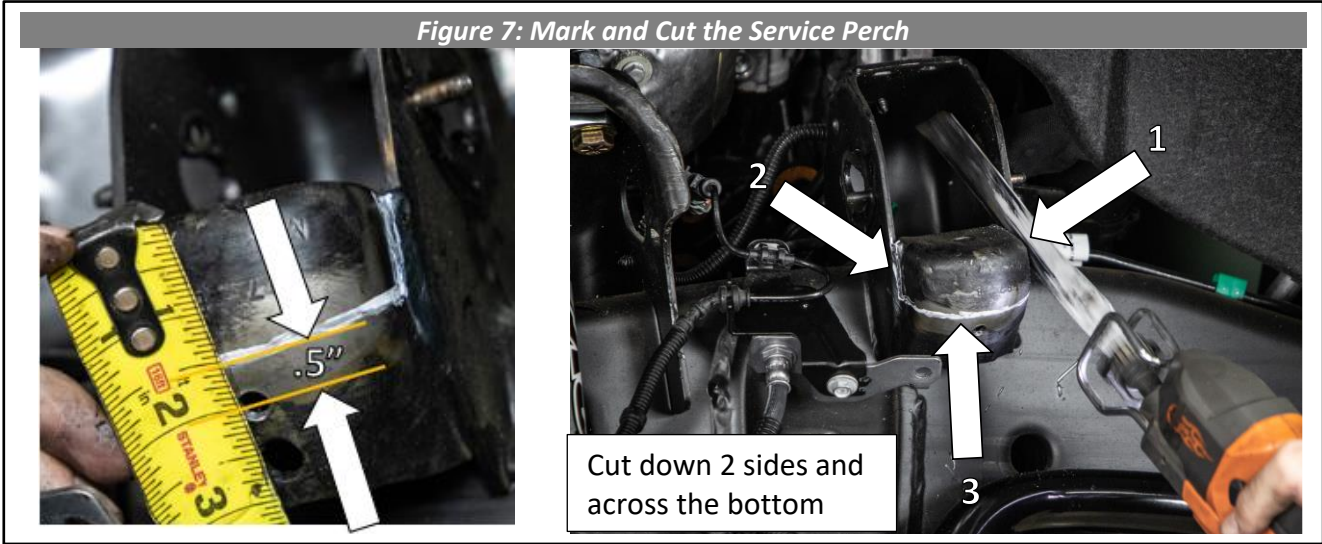

10. It is recommended that the cut areas be smoothed to get rid of any sharp edges and spray painted to prevent corrosion. Reinstall the brake line bracket in its original position. The top of the bracket should be just about flush with the bottom cut line (see figure 8). Reinstall the wheel speed sensor and brake line bracket removed in step 7.

*Figure 8: Reinstall Brake Line Bracket*

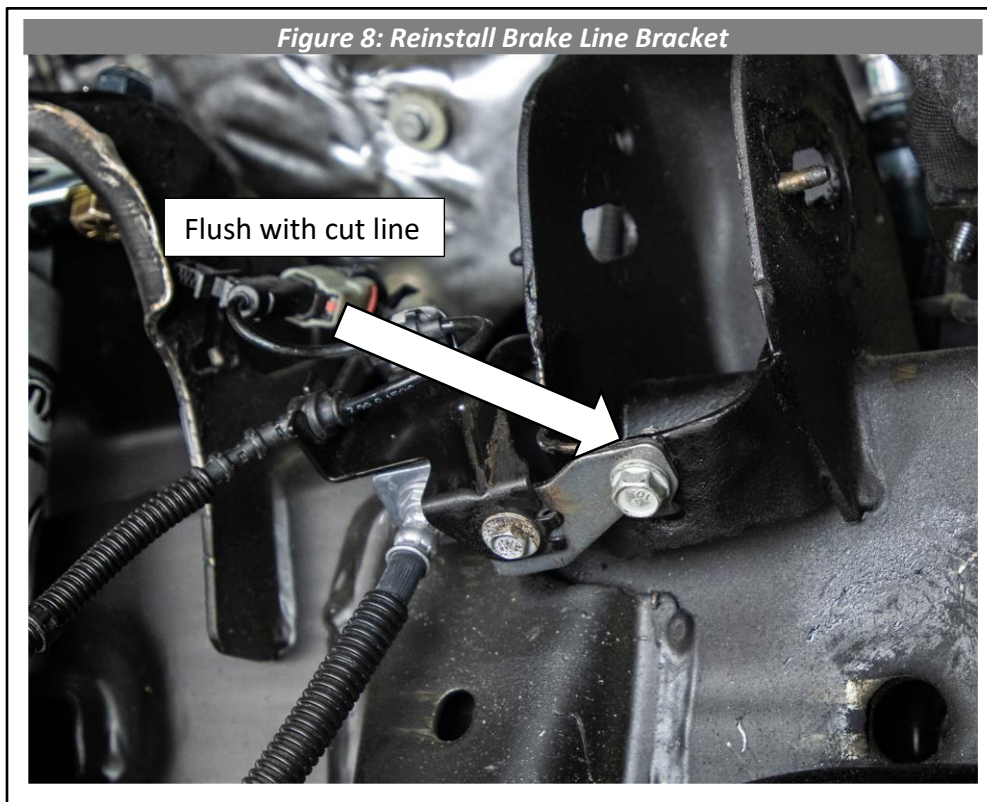

11. THE CONTROL ARMS ARE NOT THE SAME, the ball joint is moved toward the rear of the truck be sure to mount 8689 to the driver side, and 8690 on the passenger side (the Cognito logo will be closest to the front of the vehicle, and the part numbers are stamped into the bottom of the arm above the ball joint). Mount the Cognito upper control arms to the frame with the factory nuts, bolts, and eccentric washers previously removed. Set the bolts in the middle of the adjustment swing, or in the OEM plastic inserts. This will be close enough to drive to an alignment shop. Torque alignment nuts to 90 ft/lbs. (See Figure 9).

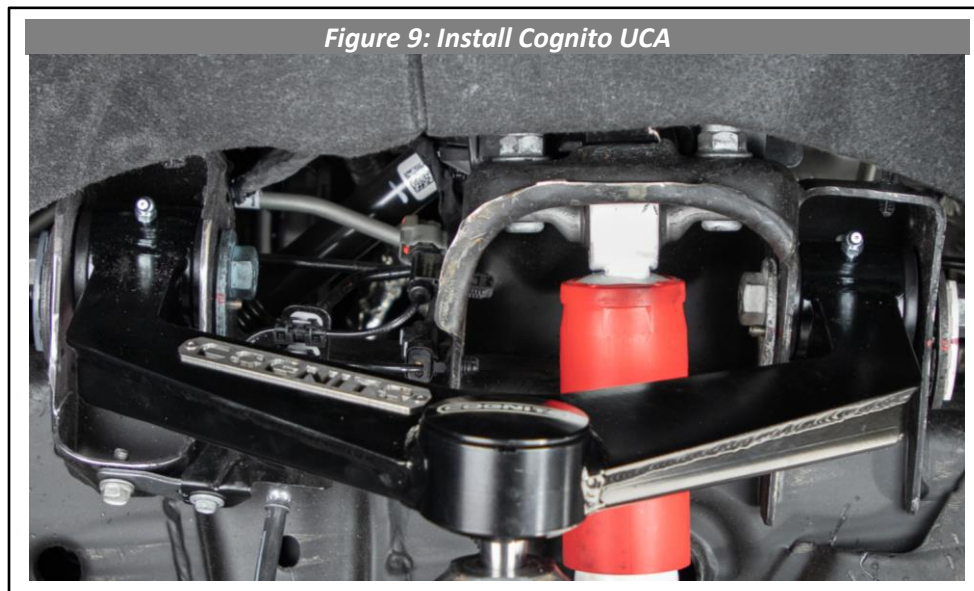

12. Mount the uniball joint to the spindle with supplied hardware. Use the M14 washer and castle nut and tighten to 80 ft/lbs of torque making sure the cotter pin hole will line up with the castle nut notch. Insert the cotter pin and bend ends around the nut to secure.
13. You may now torque the uniball pin and install the uniball cap from step 5.
14. Grease the upper control arm pivot bushings. If you do not grease this item, premature wear will result! We highly recommend greasing the pivot bushings every 3-5K miles to keep them working well. Failure to grease these items will void warranty.



**15. Setting ride height and checking for proper shock/spacer lengths (reference figure 10 and Table 1).**

Lift the truck so that the front wheels are off the ground ensuring the suspension is at full droop. Put a piece of painter’s tape at the top of the wheel well directly above the center line of the wheel. Take a measurement from the taped mark to the top of tire and record it as (A) in table 1. Subtract 3 inches from A and record this number as (B). Set the truck back on the ground and roll a minimum of 20 feet in any direction and then back to the starting point so the suspension settles out. Record this measurement from the same point on the tape to the top of tire again and record it as (C).



Table 1

Full Droop	<b>A</b>	
Max Ride Height	<b>B = A - 3</b>	
Current Ride Height	<b>C</b>	

If (C) is larger than (B), the ride height is too tall. This can be caused by shocks that are too long, too tall of a shock spacer, stacked shock spacers, torsion keys cranked too far, or any combination of the above. If the ride height is too tall, refer to step 2 and make sure the correct shock length is being used. If adjustments to the torsion keys need to be made, make sure not to tighten them while the vehicle is on the ground.

**16. Adjust headlights per owner’s manual.**

**17. Have the vehicle's front end professionally aligned using these front end alignment guidelines:**

Some Cognito upper control arms have added caster built into them to increase drivability performance, therefore it's important to be sure the correct control arm is installed on the correct side of the vehicle. It's also important to make your alignment shop aware that if caster is higher than normal for OEM, that is the intention by design.

Cross caster is important in making your vehicle track straight down the road. Most roads have crown to them, high in the middle for water runoff. This crown will make your vehicle want to pull to the right. Vehicles with stock tires on them have a narrow contact patch on the ground and are not as affected as a vehicle having larger wider tires. With larger wider tires it's important to have cross caster proper in order for the vehicle to track straight on these roads. Trucks with dual rear wheels have more tire on the ground and require more cross caster. The length of the wheelbase will also affect cross caster needed.

Generally, crew cab short and long bed trucks like .8 degrees of cross caster. For example, the driver side would have 2° while the passenger side would have 2.8° of caster. Dual rear wheel trucks like .9-1.0 degrees of cross caster. Your area might have roads that are crowned more or less than average therefore these numbers may need to change and your alignment shop should understand this. If your alignment tech is stating they can't align the truck, that typically means they can't get the alignment to OEM spec, and that's fine because your vehicle is no longer OEM. A good tech will understand this and the numbers and let caster run slightly out of OEM spec (Caster should always be above 2 degrees positive) while maintaining cross caster needed for the vehicle and roads so you enjoy your vehicle with aftermarket Cognito parts and your driving experience. Camber should always be from  $-.1^{\circ}$  to  $+.1^{\circ}$  and toe should always be .125" to .250" toe in for best tire wear.

## WARRANTY / RETURN POLICY / SAFETY

### **Cognito Limited Lifetime Warranty**

Cognito Motorsports, Inc. hereinafter “Cognito,” warrants to the original retail purchaser, that its suspension products are free from workmanship and material defects for as long as the purchaser owns the vehicle on which the product(s) were originally installed. This warranty will be void if any modifications are made to the components, including alterations to the surface finish, i.e.; painting, powder coating, plating, and/or welding, or if they are improperly installed. Cognito truck suspension products are not designed nor intended to be installed on “competition” vehicles used in race applications, stunt or for exhibition purposes that are outside of the intended operating conditions specified by the manufacturer. Racing and competition are defined as any contests between two or more vehicles; or vehicles competing individually on off road circuits in timed events (whether or not such contests are for an award or prize).

This warranty does not include coverage for police, taxi, government or commercial vehicles, and the warranty does not cover Cognito products sold outside of the USA. Cognito’s obligations under this warranty are specified and applied at its sole discretion, and warranty coverage is limited to repair or replacement of the defective product(s). Any and all costs of removal, installation or reinstallation; freight charges, incidental or consequential damages associated with the covered products are expressly excluded from this warranty.

The following items are exempt from Cognito limited warranty coverage: bushings, bump stops, tie-rod ends (Heim joints) and limiting straps. These parts are “consumables” and designed to wear as a normal part of their duty cycle, therefore they are not considered defective when worn. The aforementioned products are warranted separately against defects in workmanship, for 60 days from the date of purchase. As a condition of warranty validation, respective Cognito suspension components must be installed as a complete system (not combined with non-Cognito hardware or ancillary parts). Any substitutions or omission of required components will void the warranty. Some minor cosmetic wear and imperfections may occur to parts during shipping, which is not covered under this warranty. This limited warranty does not apply to any components that have been subjected to collision damage, negligence, alteration, abuse, or misuse, and coverage does not extend to products manufactured by third-party companies. Cognito reserves the right to supersede, discontinue, or change the design, finish, part number and/or application of its parts when deemed necessary, without notice.

### **Return Policy**

Product returns will not be accepted without prior written approval from an authorized Cognito representative. All products being returned must be shipped via trackable, prepaid freight. Returned products are subject to a 25% percent restocking fee. The eligible return period for products purchased directly from Cognito is 30 days from the verified date when the product(s) were originally received by the purchaser.

### **Product Safety Advisory**

The installation of Cognito steering and suspension components will modify your vehicle’s original factory equipment and geometry, which may cause it to handle differently than a stock (unaltered) vehicle. Installation of these components is not intended to strengthen nor reinforce the vehicle’s frame, nor are they designed to increase rollover protection. It is necessary to periodically inspect all suspension and drive train components for proper attachment, torque specifications, operation, and for any potential unusual wear or damage. Installation of these parts will modify the height of the vehicle and may raise the center of gravity. Modifying vehicle height combined with off road operation may increase your vehicle’s susceptibility to rollover conditions, which may cause serious injury or death. Many states regulate allowable vehicle height modifications, and it is your responsibility to know and comply with the legal requirements specified by the laws where you reside. Modifications to your vehicle’s ride height may also affect the ride quality, driver input response, trackability and handling, and wear to your vehicle’s suspension components and tires.